



Islamic Art and Geometric Design

ACTIVITIES FOR LEARNING

The Metropolitan Museum of Art

Islamic Art and Geometric Design

ACTIVITIES FOR LEARNING

The Metropolitan Museum of Art

Contents

| | |
|---|----|
| Introduction and How to Use These Materials | 8 |
| Introduction to Geometric Design in Islamic Art | 10 |
| Selected Works of Art in The Metropolitan Museum of Art | 12 |
| Pattern-Making Activities | 19 |
| Resources and Glossary | 43 |

Copyright ©2004 by The Metropolitan Museum of Art, New York
Published by The Metropolitan Museum of Art, New York

**This resource for educators is made possible by
the Mary and James G. Wallach Foundation.**

Education, The Metropolitan Museum of Art

Project Manager: Catherine Fukushima
Senior Managing Editor: Merantine Hens
Senior Publishing and Creative Manager: Masha Turchinsky
Illustrations and design by Tomoko Nakano

Color separations and printing by
Union Hill Printing Co., Inc., Ridgely, New Jersey

All photographs of works in the Museum's collection are by
the Photograph Studio of The Metropolitan Museum of Art
except for the following: nos. 14 and 20 by Schechter Lee;
nos. 17 and 18 by Malcom Varon, N.Y.C.

ISBN 1-58839-084-5 (The Metropolitan Museum of Art)
ISBN 1-300-10343-3 (Yale University Press)
Library of Congress Control Number: 2003110847

Preface

In 1976, Jane Norman—with help from Harry Bixler, Stef Stahl, and Margit Echols—wrote *The Mathematics of Islamic Art*, a groundbreaking Museum publication responding to the needs of math teachers eager to use the Museum’s resources in their classrooms. It became one of the Met’s most popular educational publications and has long since been out of print. This new iteration, *Islamic Art and Geometric Design*, which includes current scholarship on Islamic art as well as expanded activities developed in Museum workshops, remains indebted to Jane Norman’s work. We therefore dedicate this publication with gratitude, affection, and admiration to Jane, whose inceptive vision and passion for this project has inspired all that has followed.

Acknowledgments

We are extremely grateful to the Mary and James G. Wallach Foundation, whose grant enabled us to publish *Islamic Art and Geometric Design* and make it available to the many math, humanities, and science teachers who have requested it for use in their classrooms.

The creative vision and leadership of Jane Norman—an educator at the Metropolitan Museum for twenty-five years—are behind the original version of this publication. Over the years, other educators at the Museum, including Evan Levy, Betty Rout, Alice Schwarz, and Lena Sawyer, refined and expanded upon the initial concepts. We are indebted to Stefano Carboni, curator, and Qamar Adamjee, research assistant, both of the Department of Islamic Art, who revised the “Introduction to Geometric Design in Islamic Art” and ensured that the information about the selected works in the Museum represents the latest scholarship. Educators Nicholas Ruocco and Deborah Howes offered insight and encouragement. Emily Roth and Naomi Niles refined the bibliography. Catherine Fukushima shepherded this project, together with Merantine Hens, who coordinated the many steps of editing. Philomena Mariani edited the manuscript and Tonia Payne provided meticulous proofreading. Sue Koch of the Design Department provided valuable guidance. Masha Turchinsky art directed and managed the various aspects of production, working closely with Tomoko Nakano, who created the effective illustrations and the handsome design.

Kent Lydecker
Associate Director for Education

Foreword

Surface patterns on works of art created in the Islamic world have been prized for centuries for their beauty, refinement, harmony, intricacy, and complexity. Fine examples of Islamic art, from the seventh to the nineteenth century, can be seen in the Metropolitan Museum’s collection. This publication features a selection of those objects in which geometric patterns predominate. By using these materials teachers will be able to show their students how Islamic artists applied their imagination to an underlying geometric framework to create the patterns in these outstanding works of art. Students will also learn the principles of geometric patterns and be able to create their own. We hope that these activities will spark in your students a life-long interest in art and design.

We are fortunate indeed that these educational materials are supported by the Mary and James G. Wallach Foundation. Their contribution underscores their high commitment to art, to students, and to teachers. We are deeply grateful for their generosity.

Philippe de Montebello
Director

Kent Lydecker
Associate Director for Education

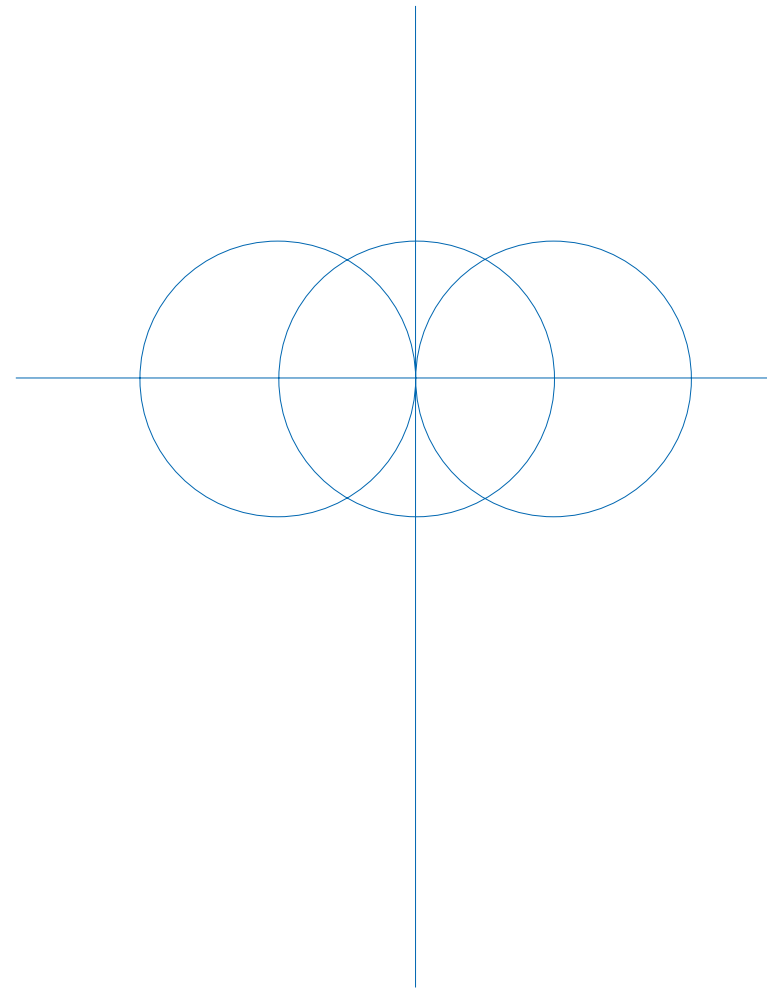

Introduction

Works of art can be stimulating starting points for interdisciplinary investigations leading students to explorations of history, social studies, geography, and culture. Less commonly, but no less intriguing, art may be a stimulus for exploring concepts in math and geometry. This resource provides the means for teaching about the history and providing an introduction to Islamic art while learning about the variety of geometric patterns employed by artists to embellish a wide range of works of art, including textiles, ceramics, metalwork, architectural elements, and manuscripts. Through the activities, students will learn the design principles and techniques by which the artists created these beautiful and intricate patterns.

How to Use These Materials

These materials may be used by a single teacher, or a team of teachers may collaborate, each working in his or her own discipline. The activities may be adapted to all levels of instruction.

We begin with an introduction to geometric patterns in Islamic art. Slides of works from the Metropolitan Museum's collection are included to show the variety and originality of these designs. A brief overview of Islamic art and individual object descriptions prepare the teacher to lead a discussion of the slides. For a chronological survey of Islamic art, teachers may refer to the *Timeline of Art History* at www.metmuseum.org/toah.

A series of activities follow. Working only with a straightedge and a compass, students will discover how to create many of the geometric shapes and patterns that Islamic artists preferred. They will also learn how the underlying grid structure serves as the foundation upon which these patterns may be infinitely repeated.

The humanities teacher will find that close study of works of art will lead students to a greater understanding of artistic and cultural concepts. Math teachers can use the activities to reinforce geometric principles. Art teachers will find that students become absorbed in the creation of their own geometric patterns. And science teachers will recognize that many underlying principles of these patterns have corollaries in the natural world.

The following suggestions are offered as guidelines when using these materials:

- Become thoroughly familiar with the materials before you use them with your students.
- Use the slides as a starting point. As students view the visual materials, they will become interested in the designs and curious about how they were created.
- Explain the traditions of Islamic art to your students. A brief introduction to Islamic art and more detailed information about the individual works of art, including title, purpose, origin, and materials, are provided.
- When viewing the slides, call attention to the intricate patterns used in the decoration

of the objects. Let your students know that they will have the opportunity to create many of these patterns themselves.

- Lead your students through the pattern-making activities. You may choose to do one, some, or all of them. A set of overhead transparencies of the activity grids in this booklet is provided for your convenience.
- After the class has completed the activities, return to the slides for a more in-depth discussion of the patterns and effects of the designs. Help the students find patterns similar to the ones they created themselves.

We hope that this publication will inspire new projects that combine visual art and mathematical and geometric concepts.

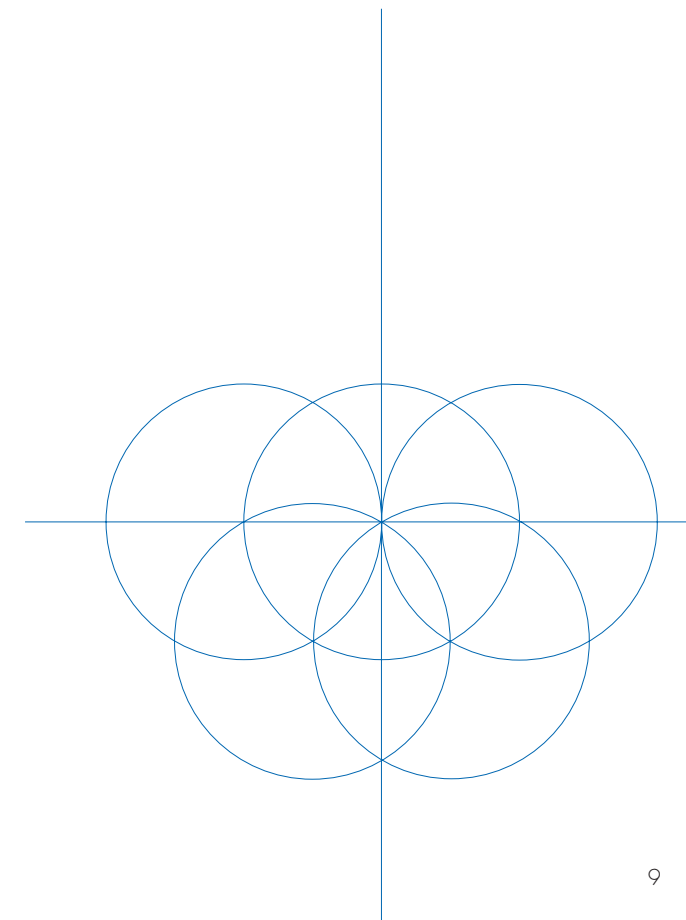

Introduction to Geometric Design in Islamic Art

The principles and teachings of Islam as a way of life, a religious code, and a legal system were promulgated by Muhammad (ca. 570–632 A.D.), an Arab merchant from Mecca. These teachings were revealed to him over a period of many years beginning in 610 and were subsequently codified in the text known as the Qur'an. The word of God, as set out in the Qur'an and handed down in the sayings of Muhammad (known as *hadith*, or Traditions), forms the core of the religion.

The primary premise of the Islamic faith is monotheism, a renunciation of all deities except one, Allah, who alone is the creator, sustainer, and destroyer of life. *Islam* is Arabic for "submission," here to the single entity of Allah. The recognition of Muhammad as Allah's last prophet, a prophet like Abraham, Moses, Jesus, and the others that preceded Muhammad, is also a key element of the belief.

Neither the Qur'an nor the Traditions contain specific mandates against figural representation in art. However, both sources take a firm stance against idolatry and the worship of images. These precepts were interpreted strictly by early Islamic religious leaders and exegetes as an injunction against the depiction of human or animal figures, although extant examples of architectural decoration, objects in all media, and illustrated manuscripts belie that stricture. Four types of ornamentation can be found in Islamic art: calligraphy, figural forms (human and animal), vegetal motifs, and geometric patterns. These patterns, either singly or

combined, adorn all types of surfaces, forming intricate and complex arrangements.

While geometric ornamentation may have reached a pinnacle in the Islamic world, sources for the basic shapes and intricate patterns already existed in late antiquity in the Byzantine and Sasanian empires. Islamic artists appropriated key elements from the classical tradition, then elaborated upon them to invent a new form of decoration that stressed the importance of unity, logic, and order. Essential to this unique style were the contributions made by Islamic mathematicians, astronomers, and other scientists, whose ideas and technical advances are indirectly reflected in the artistic tradition.

The basic instruments for constructing geometric designs were a compass and ruler. The circle became the foundation for Islamic pattern, in part a consequence of refinements made to the compass by Arabic astronomers and cartographers. The circle is often an organizing element underlying vegetal designs; it plays an important role in calligraphy, which the Arabs defined as "the geometry of the line"; and it structures all the complex Islamic patterns using geometric shapes. These patterns have three basic characteristics:

1. They are made up of a small number of repeated geometric elements. The simple forms of the circle, square, and straight line are the basis of the patterns. These elements are combined, duplicated, interlaced, and arranged in intricate combinations. Most patterns are typically based on one of two types of grid—one composed of equilateral

triangles, the other of squares. A third type of grid, composed of hexagons, is a variation on the triangular schema. The mathematical term for these grids is "regular tessellation" (deriving from Latin *tesserae*, i.e., pieces of mosaic), in which one regular polygon is repeated to tile the plane.

2. They are two-dimensional. Islamic designs often have a background and foreground pattern. The placement of pattern upon pattern serves to flatten the space, and there is no attempt to create depth. Vegetal patterns are may be set against a contrasting background in which the plantlike forms interlace, weaving over and under in a way that emphasizes the foreground decoration. In other instances, the background is replaced by a contrast between light and shade. Sometimes it is impossible to distinguish between foreground and background. Some geometric designs are created by fitting all the polygonal shapes together like the pieces of a puzzle, leaving no gaps and, therefore, requiring no spatial interplay between foreground and background. The mathematical term for this type of construction is "tessellation." The conception of space in Islamic art is completely different from Western models, which usually adopt a linear perspective and divide the picture space into foreground, middle ground, and background. Artists of the Islamic world were largely uninterested in linear perspective. Of the various styles of Islamic art, it was in Persian painting that a type of three-dimensional space was used in which figures could interact, but this space presented multiple viewpoints and simultaneously featured bird's-eye and worm's-eye views.

3. They are not designed to fit within a frame. Geometric ornamentation in Islamic art suggests a remarkable degree of freedom. The complex arrangements and combinations of elements are infinitely expandable; the frame surrounding a pattern appears to be arbitrary and the basic arrangement sometimes provides a unit from which the rest of the design can be both predicted and projected.

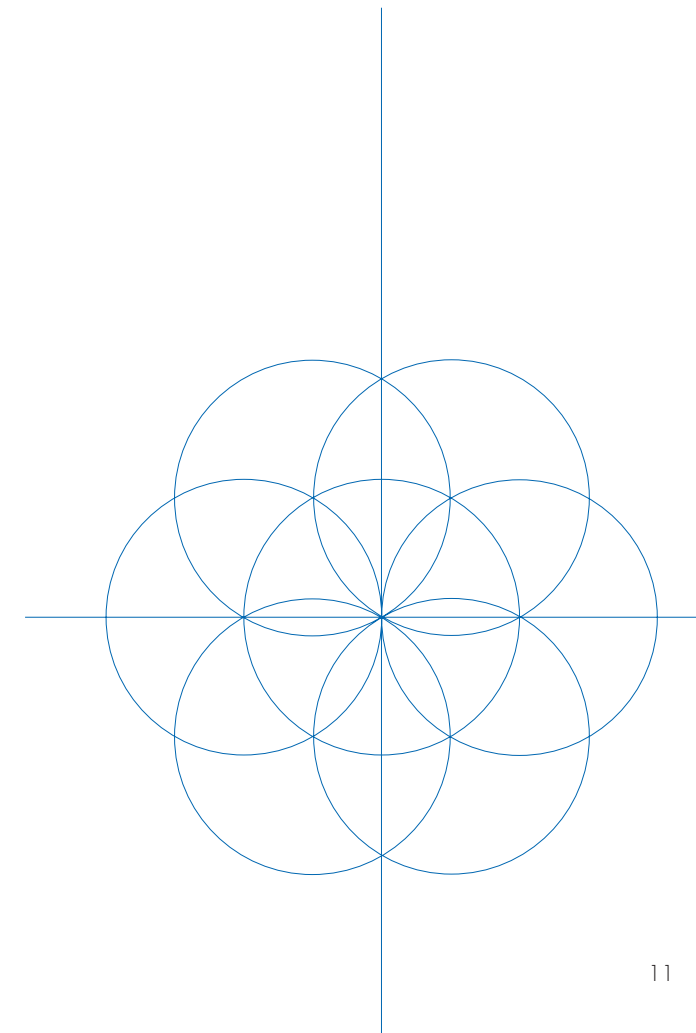

Selected Works of Art in The Metropolitan Museum of Art

1 Bowl, 9th–10th century; °Abbasid period

Iran or Iraq
Glass, free-blown and cut; H. 2 ³/₄ in. (7 cm), Diam. 3 ⁵/₈ in. (9.2 cm)
Purchase, Joseph Pulitzer Bequest, 1965 (65.172.1)

The simple geometric pattern that decorates this nearly spherical bowl represents one of the most common motifs that originated in Iran during the Sasanian dynasty and survived into the early Islamic period, when the new Muslim rulers came to power in the seventh century A.D. The design of disks with the raised dots in the center is generally known as an omphalos pattern, from the Greek word for "navel." The two evenly spaced, staggered rows of omphalos motifs in relief seem to grow out of petal-like forms that radiate from the base of the bowl, enhancing the sculptural quality of this otherwise seemingly weightless and colorless object.



2 Marquetry panel, second half of 8th century; °Abbasid period

Egypt
Wood inlaid with wood and bone; 18 ³/₄ x 76 ¹/₂ in. (47.6 x 194.3 cm)
Samuel D. Lee Fund, 1937 (37.103)

Possibly once the side of a cenotaph, this elaborately inlaid panel (shown in full in the slide) is a good example of the use of geometric motifs. The central section (illustrated at right) is based on the repetition of a square unit that contains a circle within two larger squares. The variations among the patterns utilizing the square demonstrate the synthesis of decorative freedom and structural balance achieved by skillful artists, with every square fitting into the overall grid.



3 "Nur al-Din" room, dated 1119 A.H. / 1707 A.D.;

Ottoman period
Syria, attributed to Damascus
Wood, marble, stucco, glass, mother-of-pearl, ceramics, tile, stone, iron, colors, and gold; 22 ft. ¹/₂ in. x 16 ft. 8 ¹/₂ in. x 26 ft. 4 ³/₄ in. (6.7 x 5 x 8 m)
Gift of The Hagop Kevorkian Fund, 1970 (1970.170)

This room was the winter reception room in the home of a wealthy Syrian man. Male guests would enter the room, leave their shoes at the step, and ascend to the reception area, where host and guests would relax on pillows placed on long benches that lined the wall. In the area in front of the steps, servants would prepare food, coffee, and a water pipe for the guests. The room also has niches for books, water pipes, and a collection of ceramics and metalwork. Closets were used to store mats and bedding. The floor is made of marble tiles and the wooden walls and the ceiling are ornamented with gesso. Every surface is richly decorated with multiple patterns and abundant use of gold. The decorations are mostly vegetal and calligraphic.



4 Fountain from "Nur al-Din" room

(detail of slide 3)

At the entrance to the reception room (see slide 3) is a fountain reconstructed following original models. Occupants of the "Nur al-Din" room relaxed to the sound of the water in this octagonal fountain. Around the center is a circular border divided into eight equal parts; surrounding this is a square border decorated with a thin band of tessellated hexagons.



5 Molded tile panel, 13th–14th century; Ilkhanid period

Iran, Nishapur
Ceramic with turquoise and cobalt glaze; 41 ¹/₂ x 24 in. (105.4 x 61 cm)
Rogers Fund, 1937 (37.40.26, 27)

Ceramic tiles provided a perfect material for creating tessellated patterns that could cover entire walls or even buildings. A pattern such as this required only two kinds of molds to make a beautiful and interesting design, one of the most popular of Islamic tessellations. The Western eye might read this pattern from left to right and from top to bottom, the way a page of print is read; however, any star or hexagon can serve as a central figure from which the rest of the pattern radiates. A perfect expression of radiation from a central point, the star is the most popular design element in Islamic art. The six-pointed stars in this pattern are molded with a lotus design from China, an important influence on Islamic art.



6 Glazed tile panel (detail), mid-16th century; Ottoman period

Syria
Ceramic with turquoise and cobalt colors underglaze; 21 x 30 in. (53.3 x 76.2 cm)
Rogers Fund, 1923 (23.12.3)

Even simpler than a tessellation of stars and hexagons is one of hexagons alone. In this case, the tiles have been individually painted rather than molded with a design. The central flower in each tile is a six-pointed star formed by two equilateral triangles.



- 7 Tile panel in the star-cross pattern** (detail), 13th–14th century; Ilkhanid period
Iran, Kashan
Ceramic, composite body, luster painted overglaze; 16 ³/₄ x 42 in. (42.5 x 106.7 cm)
The Edward C. Moore Collection, Bequest of Edward C. Moore, 1891 (91.1.106)
Rogers Fund, 1908 (08.110.19)
Gift of Rafael Gustavino, 1928 (28.89.4)
H. O. Havemeyer Collection, Gift of H. O. Havemeyer, 1941 (41.165.11–.13,.18,.20,.23,.32,.33,.37,.39)

This is another of the popular tessellation patterns using eight-pointed stars, many of which include a calligraphic border of Persian poetry. Several of the tiles are dated, and the distinctive pictorial way in which they are painted shows that artists in Iran employed considerable freedom with respect to the representation of animate beings. The technique of luster painting on ceramic glazes, probably invented in the ninth century, utilizes metallic pigments to produce an iridescent effect. Although the tiles fit together perfectly, the decorations are very different in subject and style.



- 8 Tile panel** (detail), 10th–11th century; Samanid period
Iran, Nishapur
Terracotta, painted; 18 ¹/₂ x 34 in. (47 x 86.3 cm)
Rogers Fund, 1939 (39.40.67)

Terracotta is baked clay, often unglazed and sometimes molded or modeled into a figure or architectural element. The glazed tiles in slides 5, 6, and 7 are called “ceramic” because their composition is more complex than clay. This panel exemplifies how geometric patterns can be revealed almost magically when individual elements of indistinct shape are assembled in larger compositions. A large octagon in the center is intersected by an interlaced design, thus creating a complex pattern. The design looks simple because it is based on half-squares with two open sides rather than half-octagons.



- 9 Pair of doors**, ca. 1325–30; Mamluk period
Egypt, attributed to Cairo
Wood inlaid with carved ivory panels; 65 x 30 ¹/₂ in. (165.1 x 77.5 cm)
The Edward C. Moore Collection, Bequest of Edward C. Moore, 1891 (91.1.2064 a,b)

Egyptian artists created very intricate designs like this one in many materials. This pair of doors from the pulpit of a mosque is made of wood strips enclosing polygons of elaborately carved ivory. The pattern of twelve-pointed stars is enclosed in congruent circles that cover the space of the doors.



- 10 Plate**, 14th century; Mamluk period
Syria or Egypt
Glass, free-blown, tooled, enameled, and gilded;
Diam. 8 ¹/₂ in. (21.6 cm)
The Edward C. Moore Collection, Bequest of Edward C. Moore, 1891 (91.1.1533)

The spectacular enameled and gilded glass objects produced by Syrian and Egyptian glassmakers from the mid-thirteenth to the late fourteenth century are unsurpassed. The decoration of this flat dish, an uncommon shape, unfolds on two levels, with the most immediate represented by the combination of the five circles—drawn in a continuous looping line—that dominate the composition. The second and subtler level is found within the four outer circles, where a complex star pattern was created. The use of colored enamels and gilding emphasizes the basic elements of the geometric and vegetal motifs in this design.



- 11 Basin**, early 14th century; Ilkhanid period
Iran
Brass, raised, engraved, and inlaid with silver and gold;
H. 5 ¹/₈ in. (13 cm), diam. 20 ¹/₈ in. (51.1 cm)
The Edward C. Moore Collection, Bequest of Edward C. Moore, 1891 (91.1.521)

This masterfully designed and executed basin is decorated with a network of nine interconnected rows of medallions or cartouches that radiate from a central sun disk. A complex series of overlapping stars, which extends into the medallions, is formed by an underlying structure of joined lines within an eighteen-sided polygon enclosed in a circle. The rim echoes the largest star created from this pattern and is itself an abstract eighteen-pointed star.



- 12 Incense burner**, late 13th–early 14th century; Mamluk period
Syria, Damascus
Brass, inlaid with gold and silver; Diam. 6 in. (15.2 cm)
Gift of J. Pierpont Morgan, 1917 (17.190.2095 a,b)

Incense burners were popular objects of domestic use. Spherical incense burners such as this one are less common than other types. The incense would be burned in a container inside this vessel and the fragrance released through the pierced body. The interior construction of this object and the surface decoration of geometric patterns within circles echo the shape of the object itself.



13 Textile fragment, 14th–15th century; Nasrid period
Spain
Silk, compound weave; 40 ³/₈ x 14 ³/₄ in. (102.6 x 37.5 cm)
Fletcher Fund, 1929 (29.22)

The patterns on this textile fragment recall the decoration on the tiles and painted stucco adorning the walls of the Alhambra in Granada, the capital of the Nasrids, the last ruling Islamic dynasty in Spain. The various forms of Islamic ornament are presented on this textile with brilliant contrasting colors to create a sense of animation and balance. The main repetitive motif in the geometric bands consists of an eight-pointed star formed by two overlapping squares. Vegetal patterns, knotted angular *kufic* script, and cursive *naskh* script in the cartouches above and below the *kufic* bands enhance the overall geometric effect of the design.



14 Openwork screen (*jali*), ca. 1610; Mughal period
India, probably Agra
Marble; 48 ¹/₈ x 16 ¹/₂ in. (122.2 x 41.9 cm)
Rogers Fund, 1984 (1984.193)

Pierced screens (*jalis*) of pink sandstone or white marble were widely used in Mughal India and fulfilled many architectural functions, serving as windows, room dividers, and railings. They allowed for the circulation of air and provided shelter from sunlight, but the geometric patterns and their projected shadows also produced aesthetic effects.

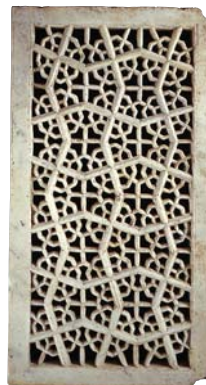

15 Bowl, late 12th–early 13th century; Seljuq period
Iran
Mina'i ware; composite body, opaque white glaze with gilding, overglaze painting; H. 3 ¹¹/₁₆ in. (9.4 cm), diam. 7 ³/₈ in. (18.7 cm)
Purchase, Rogers Fund, and Gift of The Schiff Foundation, 1957 (57.36.4)

Mina'i ware was produced in Iran in the Seljuq period. The ceramics were noted for colorful figurative painting on a white glaze. As one of the many conquering peoples who rode into the Middle East from the Central Asian steppes, the ruling-class Turks are appropriately shown on horseback, their Asiatic features easily distinguishable. The shape of the bowl is echoed in the design at its center—a round sun, shown as a face, surrounded by the sun's rays, and around them, six regularly spaced figures representing the moon and five planets. This construction could easily lead to a pattern of hexagons or six-pointed stars.



16 Leaf from a Qur'an manuscript, 1302–8; Ilkhanid period
Iraq, Baghdad
Ink, gold, and colors on paper; 17 x 13 ⁷/₈ in. (43.2 x 35.2 cm)
Rogers Fund, 1950 (50.12)

Traditions of bookmaking were well developed in Islam by the eighth and ninth centuries, although such fully developed illumination as that on this leaf seems not to have become widespread until the eleventh century. Copies of the Qur'an received the greatest artistic attention and care. In this example, which represents the right side of a double-page composition, many designs cover the entire surface of the page. In the center of the page lies a richly designed square decorated with complex geometric shapes and foliage designs. Above and below the square are two narrow rectangles decorated with calligraphic words set over leaves and vines. Over the entire space, carefully fitted into the geometric design, is a pattern of leaves and flowers in diverse colors. Above and below the square are two narrow rectangles, which complete the design of the page. This sumptuous gold frontispiece uses a pattern of eight-pointed stars.



17 *Laila and Majnun at School: Miniature from the Khamseh of Nizami, folio 129a*
16th century; Safavid period
Iran

Ink, colors, and gold on paper; 7 ¹/₂ x 4 ³/₄ in. (19 x 12 cm)
Gift of Alexander Smith Cochran, 1913 (13.228.7)

Manuscript pages would have been executed in two stages. First the calligrapher would write the portion of the story to be illustrated, then the painter would compose pictures in the space left by the calligrapher. Persian painters loved to depict the scene from Nizami's immortal romance, where Laila and Majnun as children attend the same school. These paintings give us a fascinating glimpse of the goings-on in a classroom.

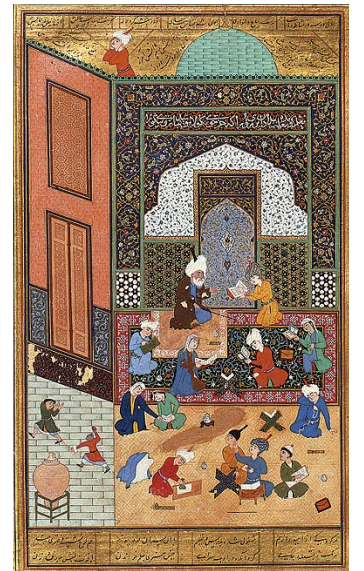

18 *Laila and Majnun at School: Miniature from the Khamseh of Nizami, folio 129a*
(detail of slide 17)

This detail shows the painter's ability to combine different patterns to create a surface richness that contradicts the sense of space suggested by certain lines of perspective. Note the two designs using six-pointed stars.



19 *Mihrab*, 1354; post-Ilkhanid period

Iran, attributed to Isfahan

Mosaic of monochrome-glaze tiles on composite body set on plaster; 11 ft. 3 in. x 7 ft. 6 in. (3.4 x 2.9 m)

Harris Brisbane Dick Fund, 1939 (39.20)

The most important interior element in an Islamic religious building is the *mihrab*, a wall niche that indicates the direction of Mecca, toward which the faithful must face during the daily prayers. This *mihrab* is from the Madrasa Imami, a religious school founded in Isfahan in 1354. It is made of glazed earthenware cut into small pieces and embedded in plaster. Three kinds of Islamic designs can be found here—vegetal, calligraphic, and geometric. The calligraphic inscription in the back of the niche reads: "The Prophet (on him be peace!) said 'the mosque is the dwelling place of the pious.'" Calligraphy is the most revered art form in Islam because it conveys the word of God. Note the way in which straight-lined geometric shapes have been made to fit the curved space. Observe the varied and complex decorative elements that cover every visible surface of the *mihrab*. All directly illustrate geometric, calligraphic, or plant forms.



20 *Tombstone*, 753 A.H. / 1352 A.D.

Iran

Limestone; 32 3/4 x 21 3/4 in. (83.2 x 55.3 cm)

Rogers Fund, 1935 (35.120)

This tombstone recalls a *mihrab* niche. A common decorative feature seen on mosque arches, domes, and sometimes on *mihrabs* are the three-dimensional forms known as *muqarnas*, or stalactites. Students should try to determine how the pattern of stalactites was formed. While the four main types of Islamic ornament were often included in various combinations or all together on a single surface, in other instances, one type of decoration was made to conform to the specifications of another, here seen by the geometric application of calligraphy. The inscriptions on the tombstone—inside the niche, in the diagonally set square above the niche, and on the inner band that frames the niche—are a perfect example of the technique of rendering square *kufic* calligraphy. This style evolved during the medieval period for use on architecture because the angular Arabic letters fit easily into architectural spaces and could be conformed to the rectangular shapes within the overall structure.

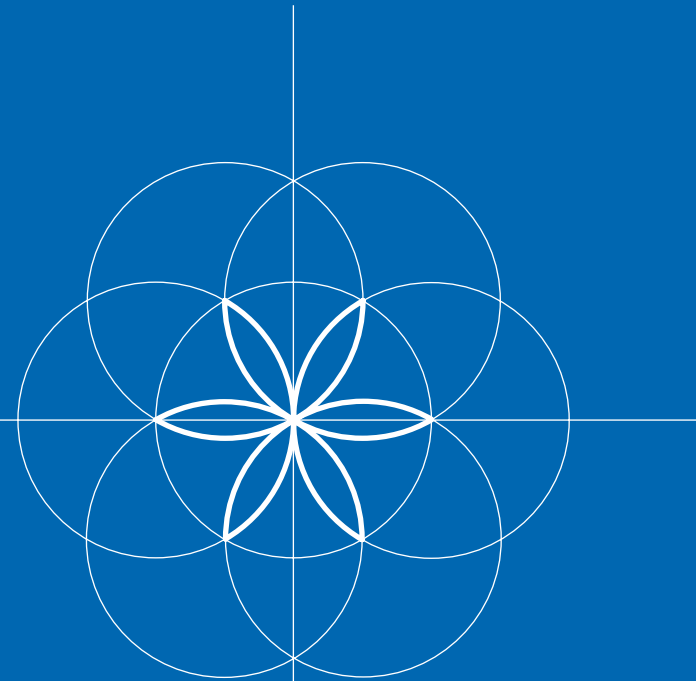

Introduction

Through these activities, students will discover the satisfaction that comes with the creation of designs through the use of two simple tools—a compass and a straightedge. By creating patterns themselves, students will gain an understanding of geometric principles of the underlying grids and methods used by Islamic artists.

Each activity lists the materials needed in a box in the upper right corner and illustrates how to do the activity. Pages of this booklet providing grids and the circle template may be photocopied for use with your class. A set of overhead transparencies of the activity grids in this booklet is provided for your convenience.

Students begin by making single circles with a compass. By using two different arrangements of circles, students will be able to create a variety of geometric forms, including rosettes, hexagons, and eight-pointed stars. The next set of activities demonstrates how the two arrangements of circles are used to create various grids. Using these grids, students can create an infinite variety of patterns. The final activity is a class project in which students cut and decorate six- and eight-pointed stars to form two of the most popular Islamic patterns—the hexagon and the star-cross.

Activity 1

Seven Overlapping Circles

paper,
straightedge,
compass,
marker

1. Using a straightedge, draw a horizontal line near the center of the paper.

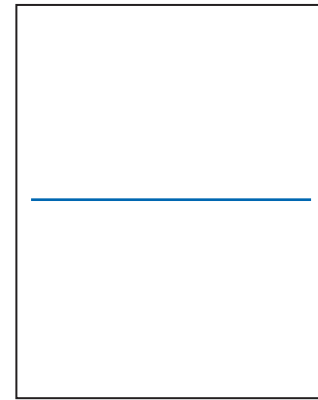

2. Make a circle with the compass point placed near the center of the line. Using the intersection points as new compass points, draw a circle on either side of the first circle.

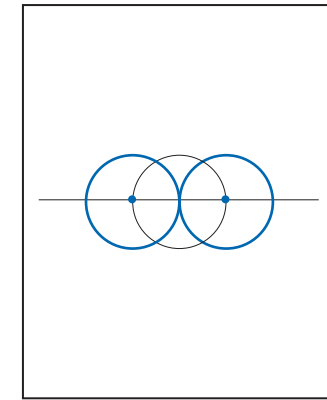

3. Add four more circles using the new points of intersection as compass points. It is important that all circles have the same radius.

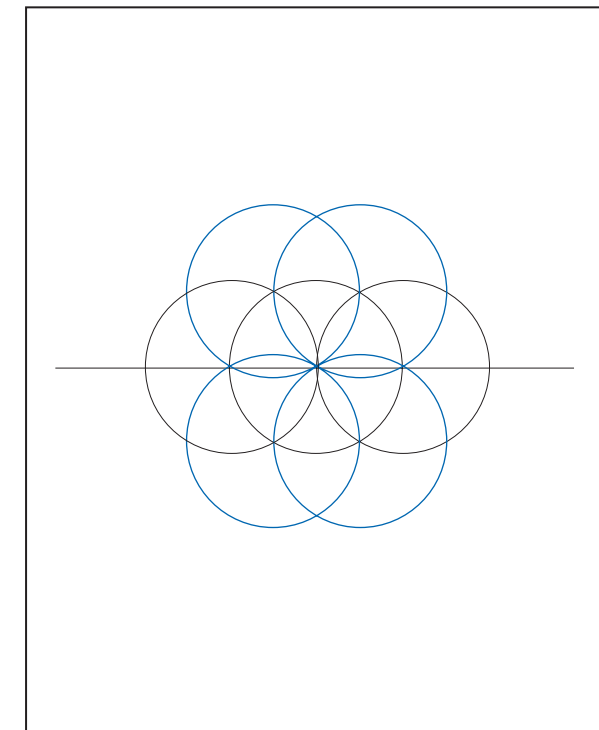

Activity 2

Finding Geometric Shapes within Circles

For examples see **Fountain from Nur al-Din room** (slide 4) and **Laila and Majnun at School: Miniature from the Khamseh of Nizami** (slides 18)

Using the seven overlapping circles design created in Activity 1, students will be able to find three possible shapes: rosette, hexagon, and equilateral triangle. Use a marker to highlight each shape.

straightedge, marker,
three examples of the
seven overlapping circles
design made in Activity 1

Rosette

The rosette divides the central circle into six equal parts and locates six equally spaced points on its circumference—a result of all the circles having the same radius.

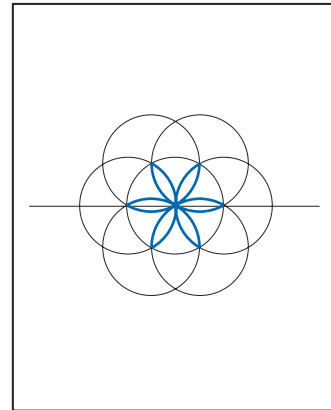

Hexagon

To make a hexagon, use a straightedge to join adjacent circumference points on the central circle.

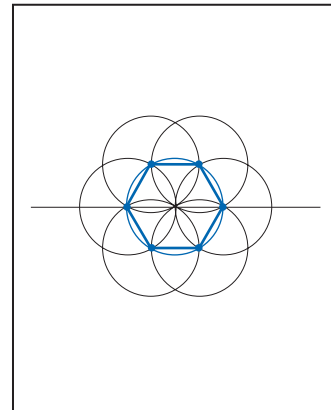

Two equilateral triangles

To create two equilateral triangles, join every second point. Notice that these two triangles form a six-pointed star.

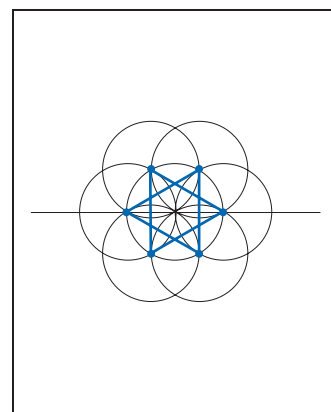

Finding Geometric Shapes within Circles

For an example see **Pair of doors** (slide 9)

straightedge, pencil,
one rosette made
earlier in this activity

1. Start with the rosette on the opposite page.

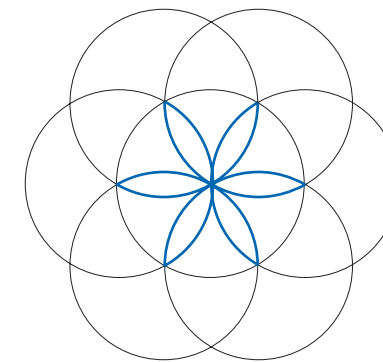

2. Connect every other point of the rosette to produce a six-pointed star with overlapping triangles and a hexagon in the center.

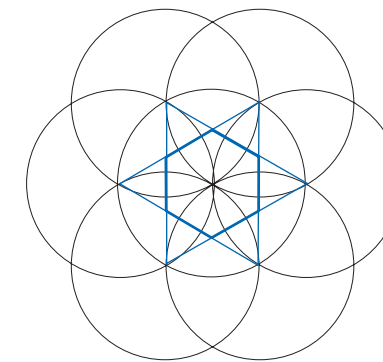

3. Connect opposite corners of the hexagon within the star. Extend the lines to the edge of the central circle to divide the star into twelve equilateral triangles. Erase the lines inside the central circle, leaving the circle and line end points visible.

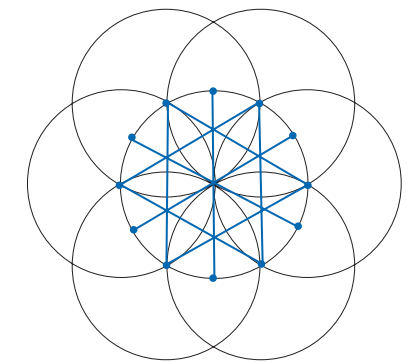

4. Connecting every fifth point will produce a twelve-pointed star.

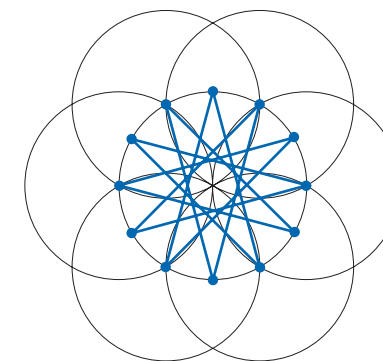

Activity 3

Creating Triangle and Hexagon Grids

For an example see *Laila and Majnun at School: Miniature from the Khamseh of Nizami* (slide 17)

In Activity 1, if you had continued adding overlapping circles at the intersection points, the result would be a circle grid as shown in the seven overlapping circles grid (fig. 1). This circle grid is the basis for both the triangle grid and the hexagon grid.

straightedge, two different colored markers, tracing paper, seven overlapping circles grid (fig. 1)

1. On the seven overlapping circles grid (fig. 1), place a dot at the center of each rosette.

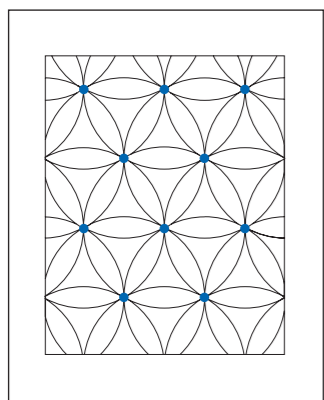

2. Place the tracing paper over the circle grid, and connect the dots in horizontal and diagonal lines to make a triangle grid.

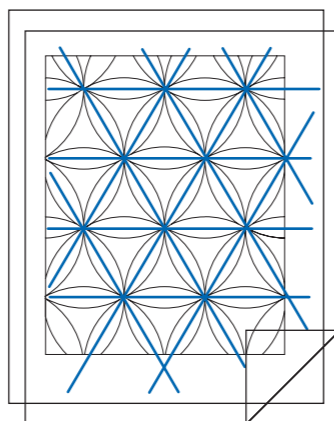

3. Now you have the triangle grid on the tracing paper. Using a different color of marker, mark the hexagon grid by highlighting the outer edge of six adjoining triangles, as shown.

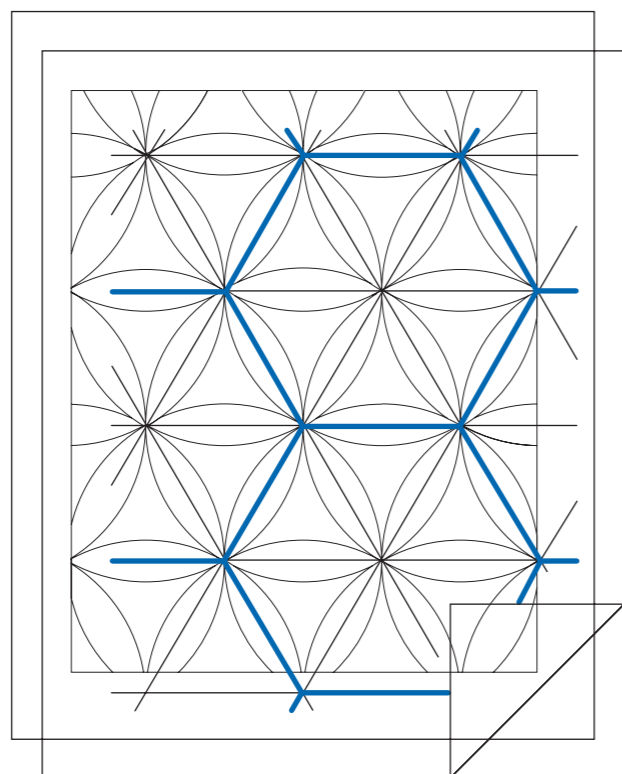
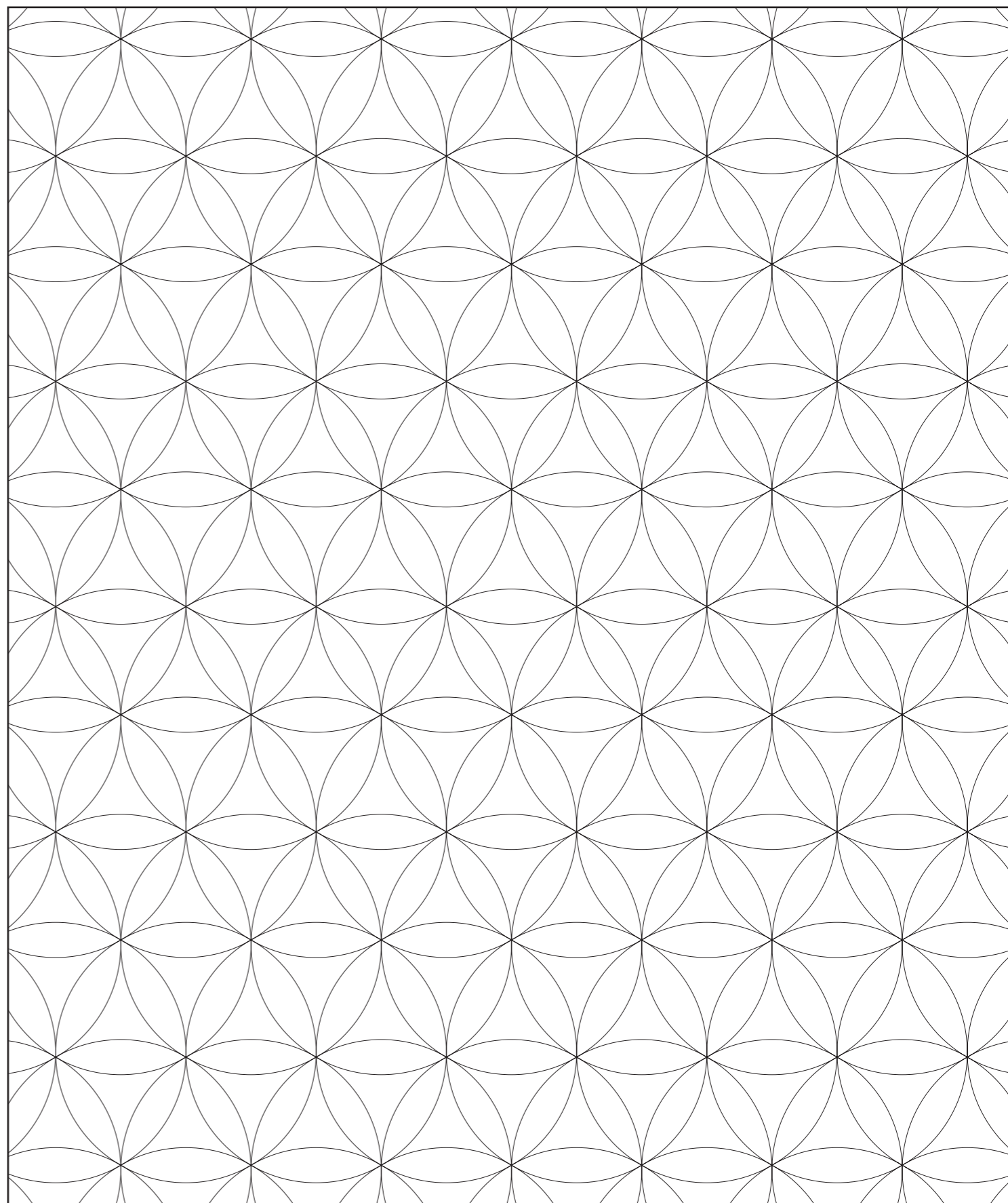

fig. 1

Seven Overlapping Circles Grid



Activity 4

From One Circle to Five Overlapping Circles

paper,
straightedge,
compass,
marker

1. Bisect the page by drawing one horizontal and one perpendicular line. Mark the center as **A**.

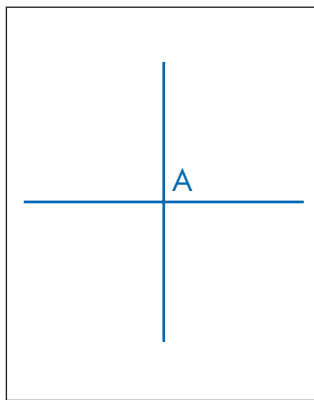

2. Place the compass point at point **A** and draw a circle. Leave room to draw equal sized circles on each side, at the bottom, and at the top. Mark the points that cross the lines **B, C, D, and E**.

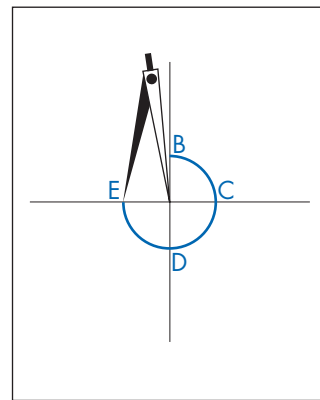

3. Using points **B, C, D, and E**, draw four more circles. Mark the points where the four circles intersect **F, G, H, and J**.

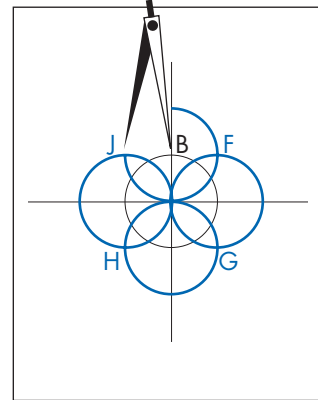

4. Use a straightedge to draw the lines **FH** and **JG** through the center. These lines intersect the original circle at four equally spaced points at **K, L, M, and P**.

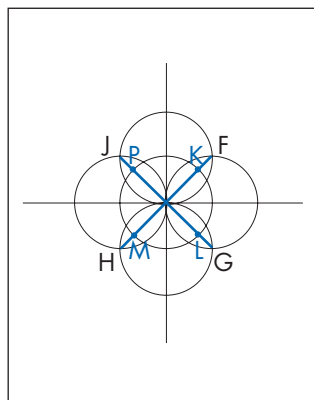

5. The straight lines both divide the circle into eight equal parts and locate eight equally spaced points—**B, C, D, E, K, L, M, P**—on the circumference of the original circle. This is the result of the five circles having the same radius. These points can be used to form octagons, eight-pointed stars, and four-pointed stars, as shown in Activity 5.

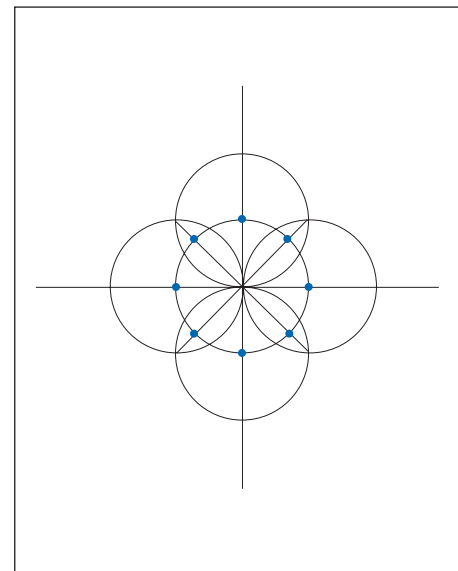

Activity 5

Finding Geometric Shapes within Circles

For examples see **Textile fragment** (slide 13) and **Leaf from a Qur'an manuscript** (slide 16)

straightedge, marker,
four copies of the five
overlapping circles design
made in Activity 4

Octagon

To create a regular octagon, use a straightedge to join adjacent points on the circumference of the original circle.

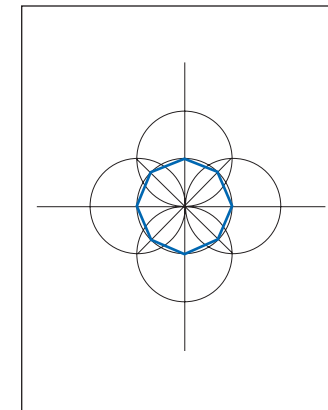

Eight-pointed star, version 1

By joining every second point on the original circle, you will create two squares that overlap to form an eight-pointed star.

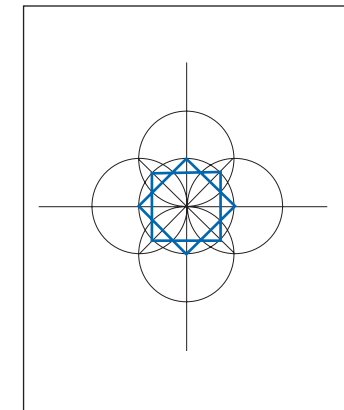

Eight-pointed star, version 2

By joining every third point, you will create a different eight-pointed star.

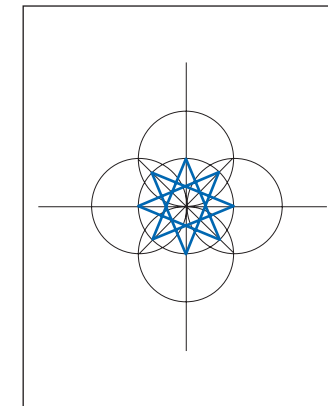

Four-pointed star

Embedded in the eight-pointed star (version 2) is a four-pointed star.

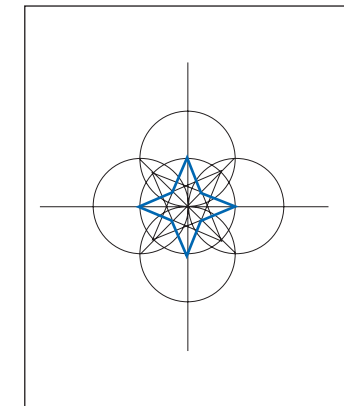

Activity 6

Creating Square Grids from Circles

For an example see **Marquetry panel** (slide 2)

In Activity 4, if you had continued adding overlapping circles at the intersection points, the result would be a circle grid as shown in the five overlapping circles grid (fig. 2). This circle grid is the basis for the square grid and the diagonal grid.

1. On the five overlapping circles grid (fig. 2), place a dot at the point where each circle meets.

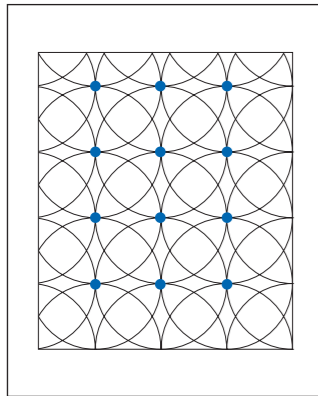

2. With the tracing paper over the circle grid, connect the dots horizontally and vertically to make a square grid.

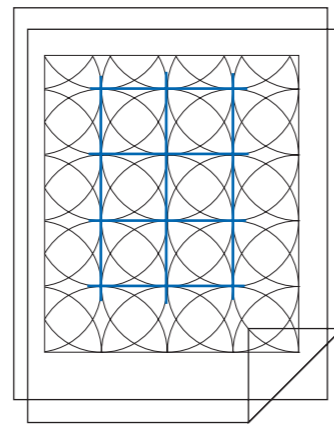

3. Now you have the square grid on the tracing paper. Using the straightedge and a different colored marker, mark diagonal lines.

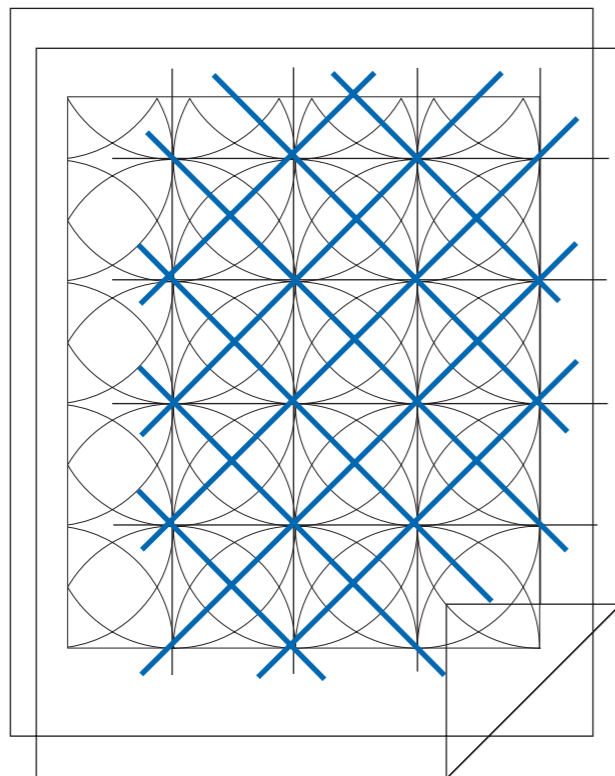

tracing paper, two different colored markers, straight-edge, five overlapping circles grid (fig. 2)

fig. 2

Five Overlapping Circles Grid

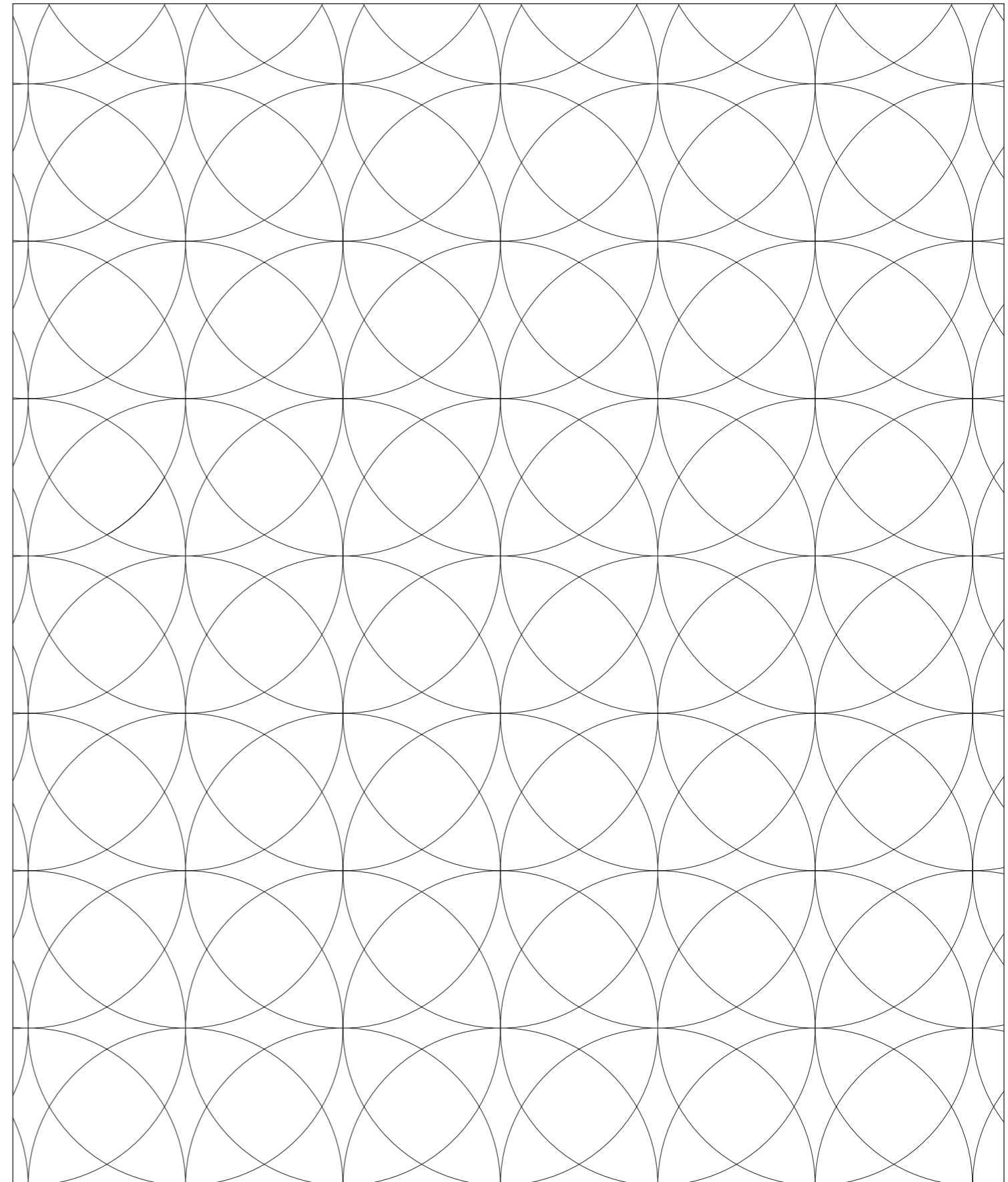

Activity 7

Discovering Patterns within the Triangle Grid

For examples see **Molded tile panel** (slide 5) and **Glazed tile panel** (slide 6)

tracing paper, marker,
triangle grid (fig. 3)

1. Place the tracing paper over triangle grid (fig. 3).
2. Select any one of the three patterns below and, on the tracing paper, copy only those lines that will create your selected pattern. Use the lines of the grid as a guide.
3. Repeat with the other patterns.

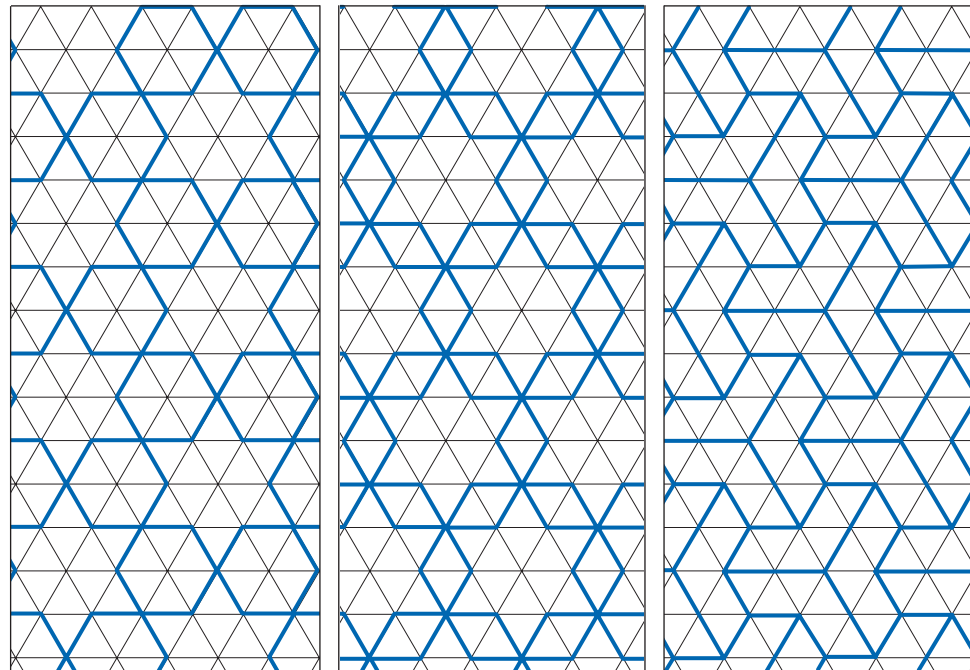
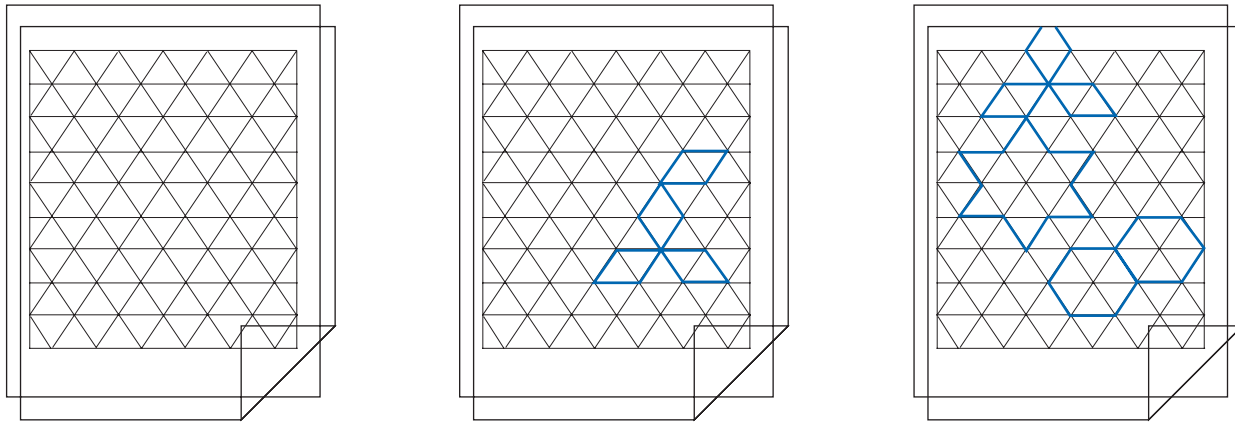
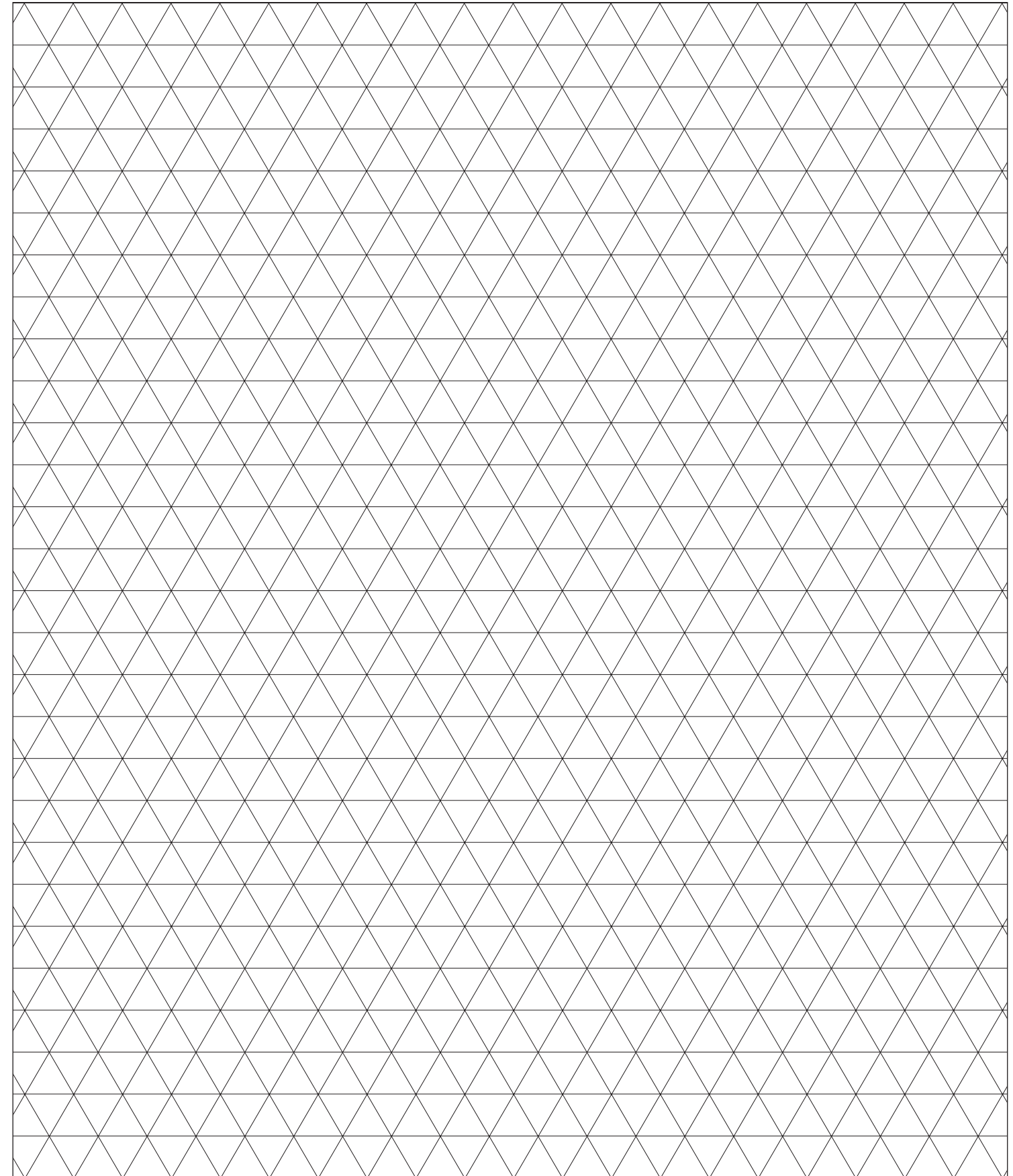

fig. 3

Triangle Grid



Activity 8

Discovering Patterns within the Five Overlapping Circles Grid

For an example see **Mihrab** (slide 19)

tracing paper, marker,
five overlapping
circles grid (fig. 4)

1. Place the tracing paper over the five overlapping circles grid (fig. 4).
2. Select any one of the three patterns below and, on the tracing paper, trace only those lines that will create your selected pattern. Use the lines of the grid as a guide.
3. Repeat with the other patterns.

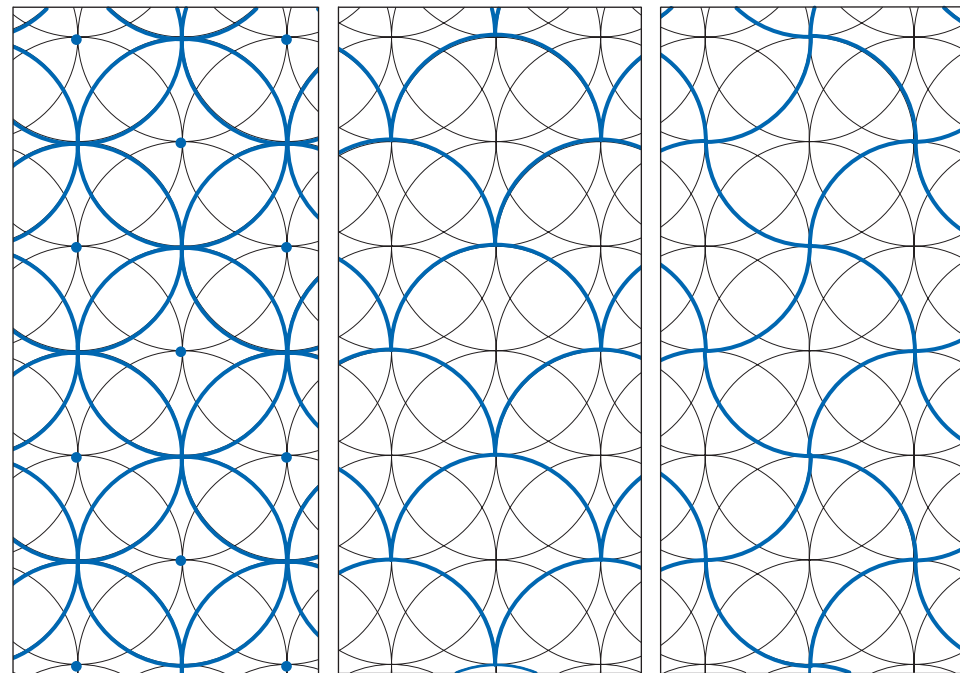
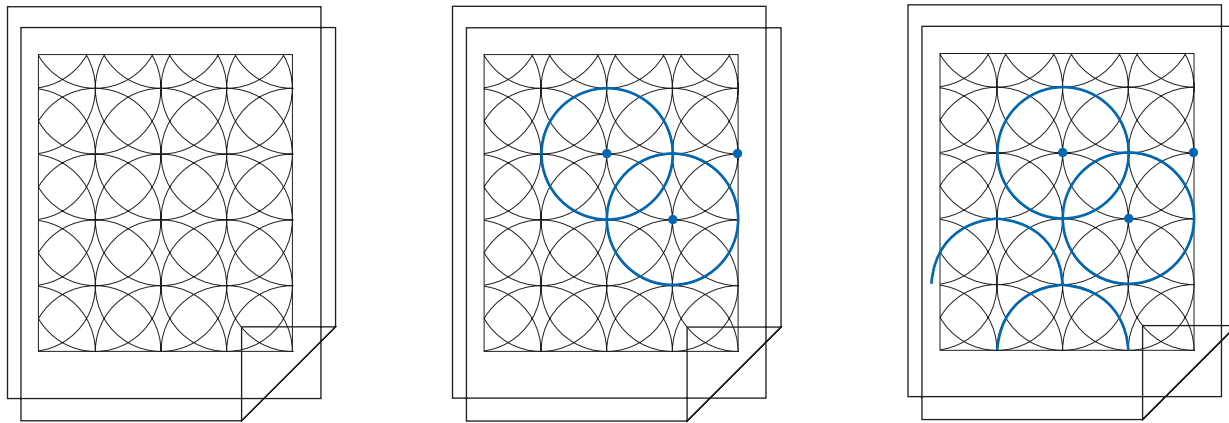
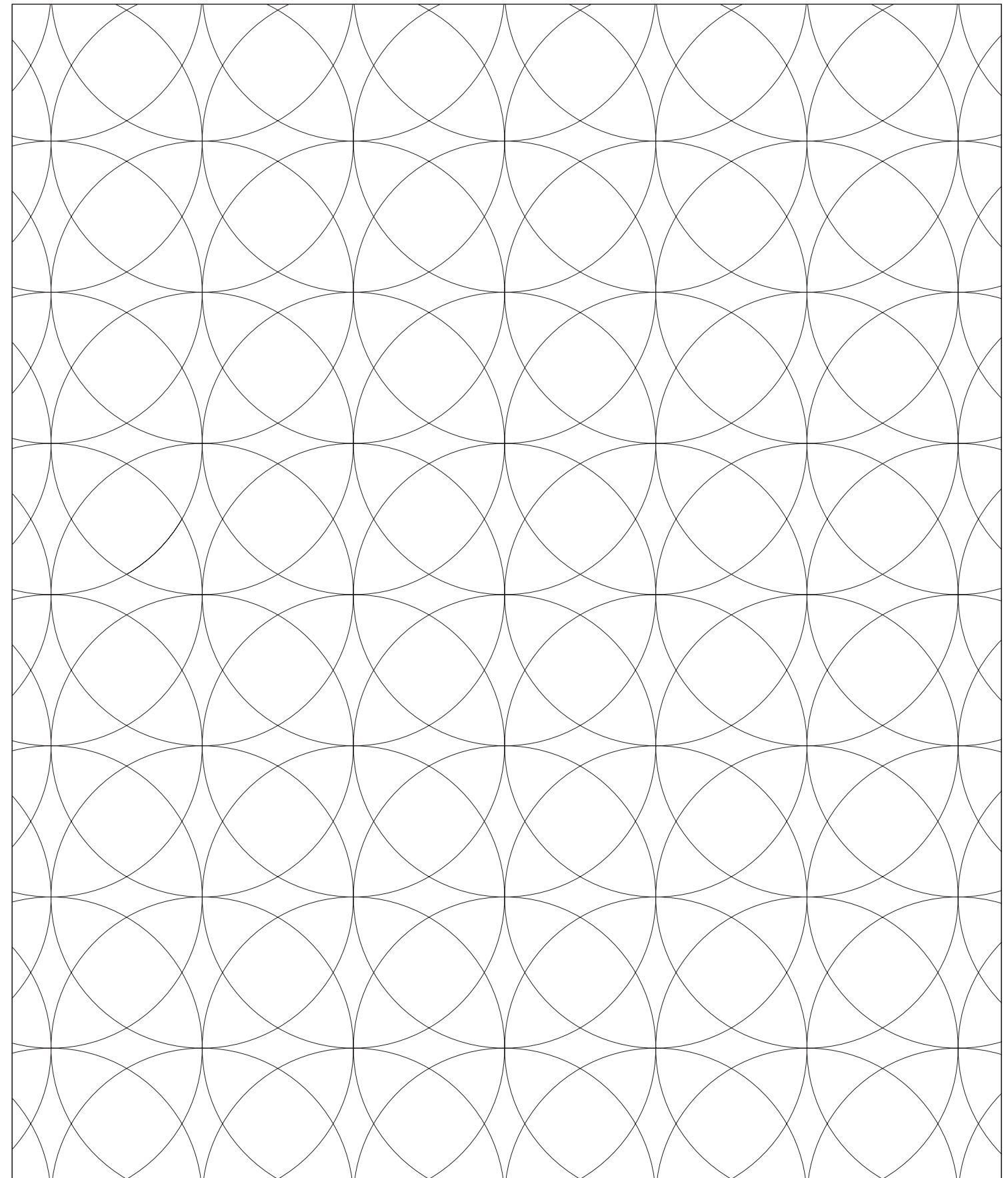

fig. 4

Five Overlapping Circles Grid



Activity 9

Discovering Patterns within the Seven Overlapping Circles Grid

For an example see **Bowl** (slide 1)

1. Place the tracing paper over the seven overlapping circles grid (fig. 5).
2. Select any one of the three patterns below and, on the tracing paper, copy only those lines that will create your selected pattern. Use the lines of the grid as a guide.
3. Repeat with the other patterns.

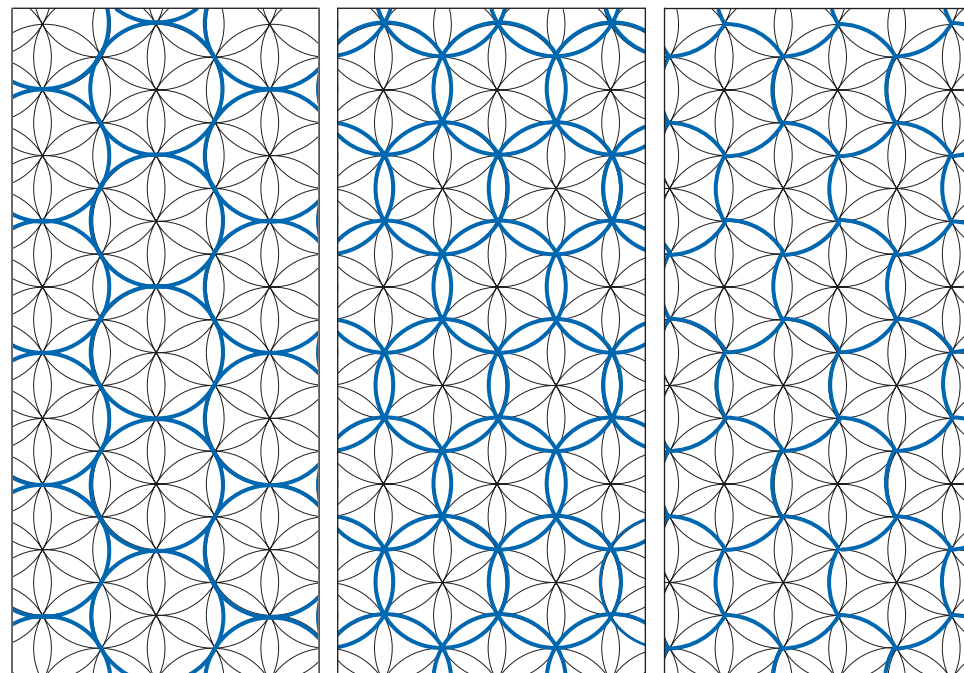
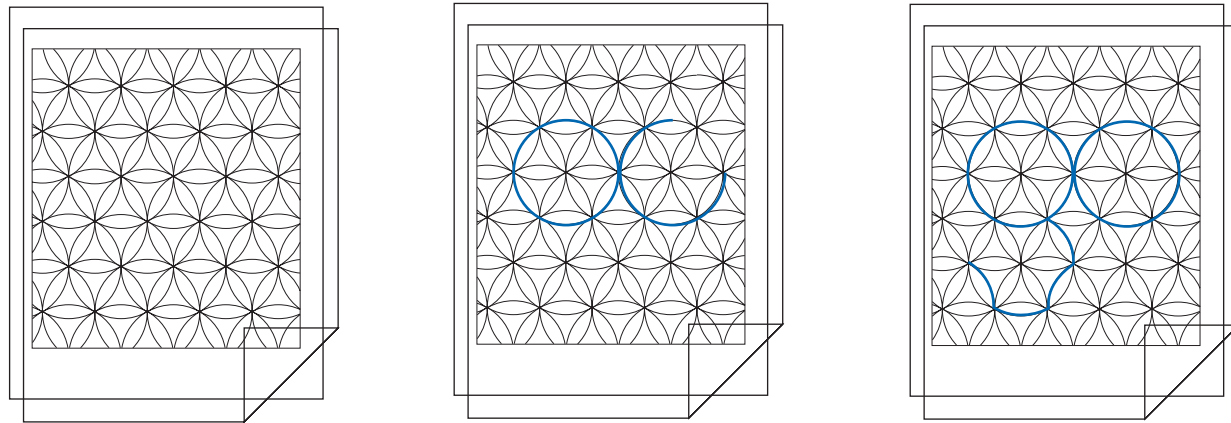

tracing paper, marker,
seven overlapping
circles grid (fig. 5)

fig. 5

Seven Overlapping Circles Grid

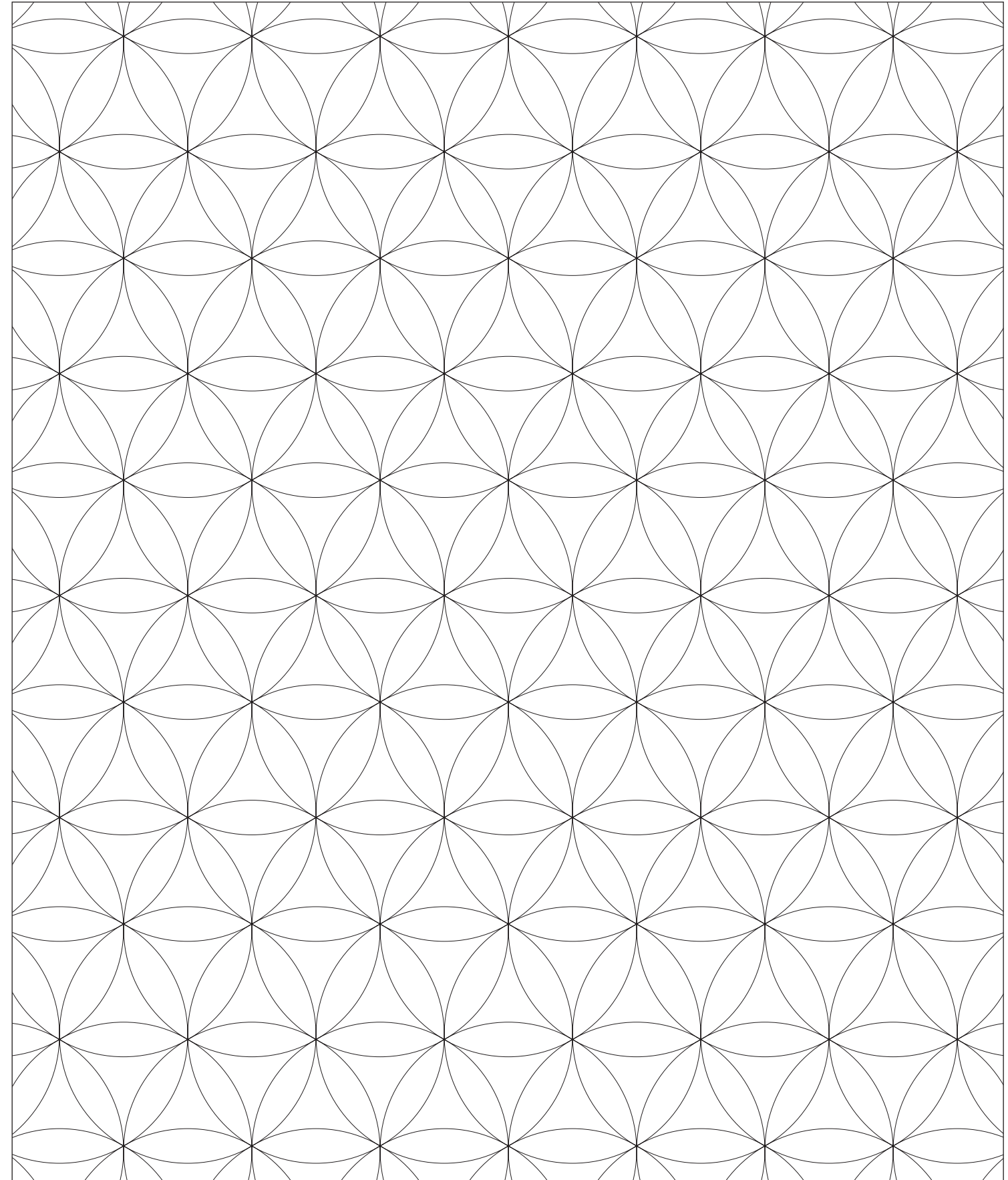

Activity 10

Discovering Patterns within the Diagonal Grid

For an example see **Tile panel in the star-cross pattern** (slide 7)

tracing paper, marker,
diagonal grid (fig. 6)

1. Place the tracing paper over the diagonal grid (fig. 6).
2. Select one of the three patterns below and, on the tracing paper, trace only those lines that will create your selected pattern. Use the lines of the grid as a guide.
3. Repeat with the other patterns.

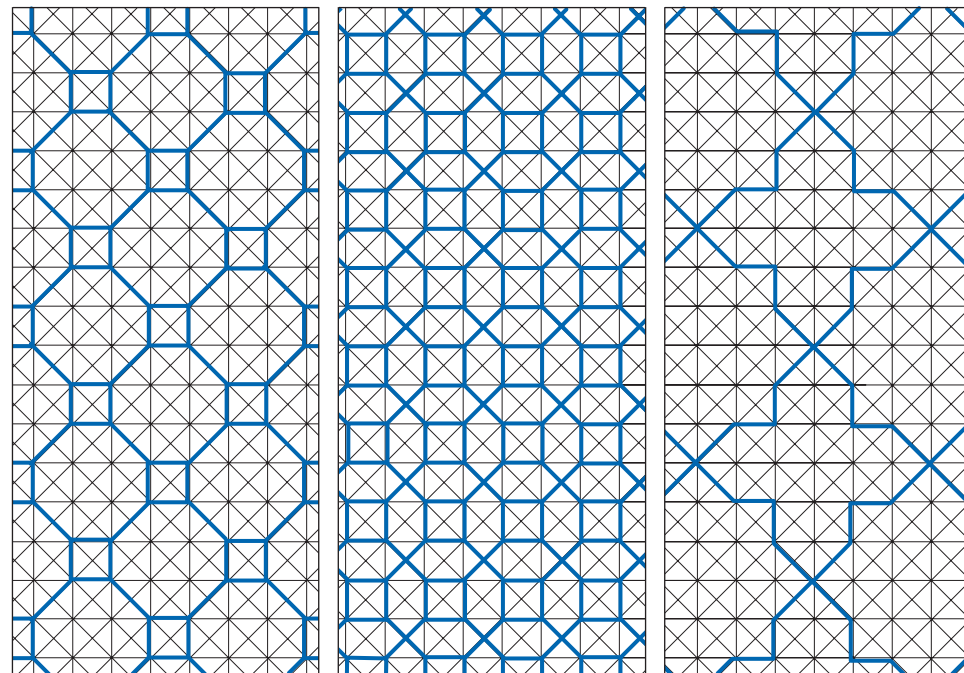
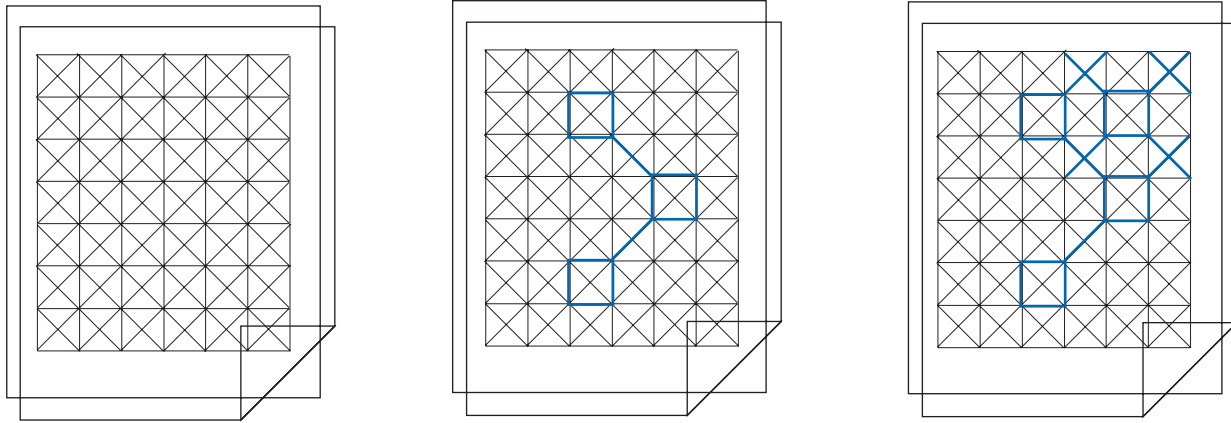
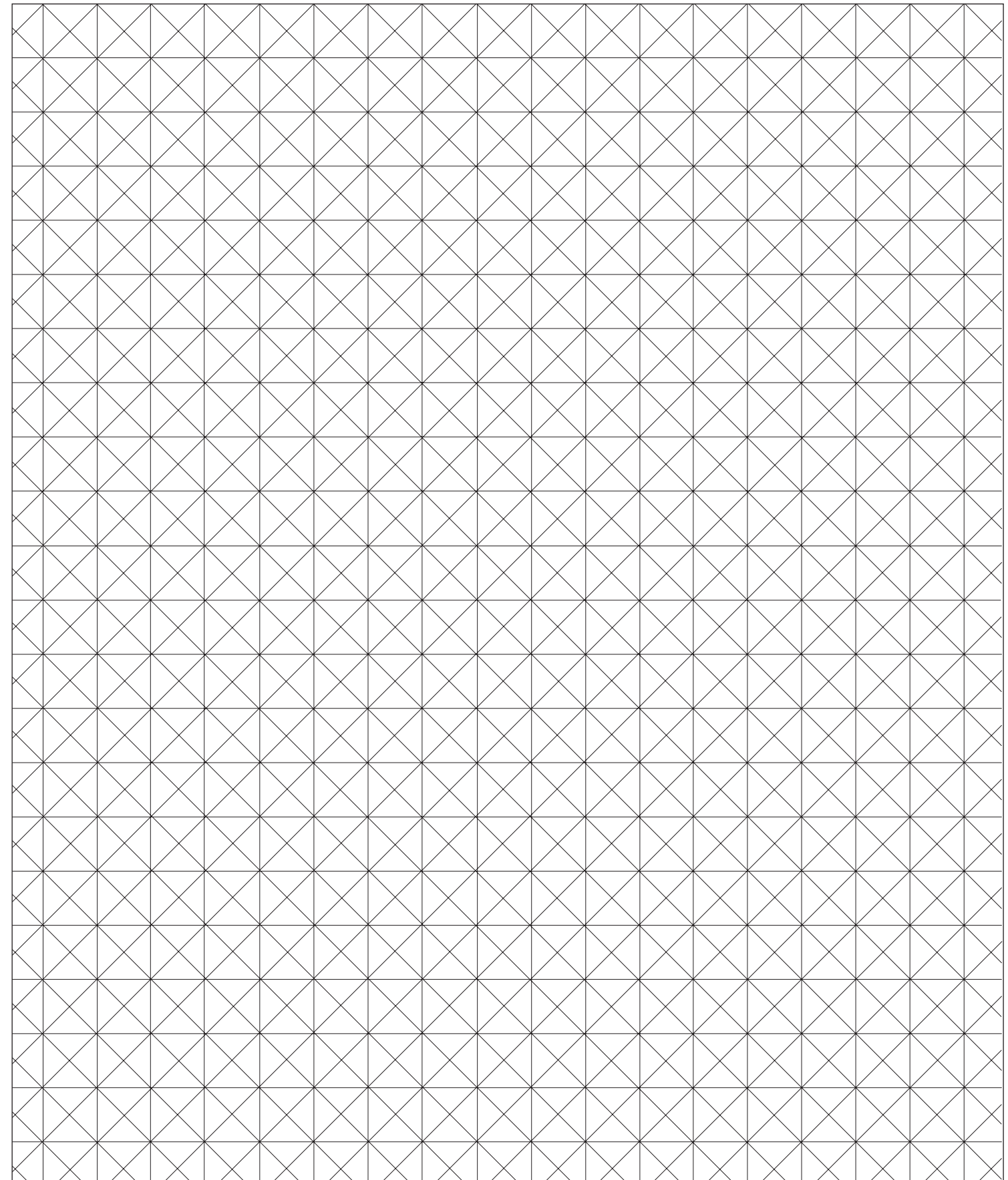

fig. 6

Diagonal Grid



Activity 11

Class Project with Cut-Out Stars Constructing and Decorating the Stars

compass, scissors, colored markers, circle (fig. 7), flat surface for mounting the finished stars. (The flat surface can be a poster board or paper. Size will depend on the number of stars you have.)

Constructing a Six-Pointed Star

1. Using fig. 7, begin by carefully cutting out the circle.

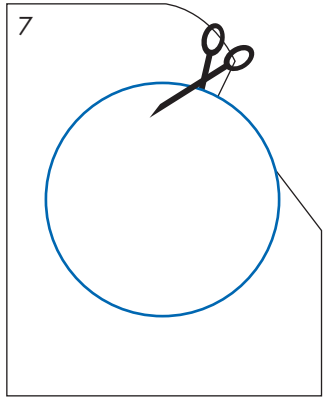

2. Fold the circle in half.

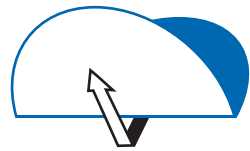

3. Fold A over to B.

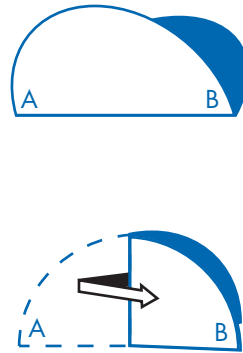

4. Measure line CD. At the halfway point, mark point E. Keeping a sharp point at B, fold along line BE. Where C now touches the circle's edge, mark point F.

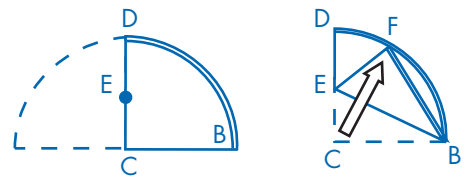

5. Unfold. Fold to the back along axis CF.

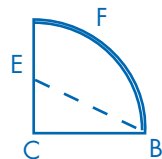

6. Fold B up to meet point F. If you look at the folded circle edge on, it should make a zigzag.

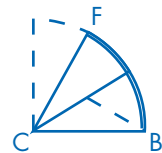

7. Hold the folded circle so you can see where fold BE (created in step 4) meets the outer edge of the circle. Cut along fold line BE.

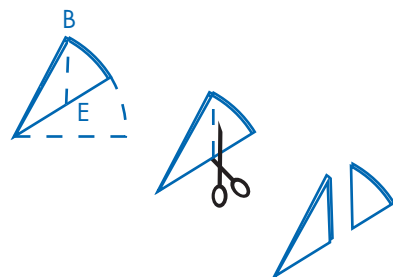

8. Open to discover six-pointed star.

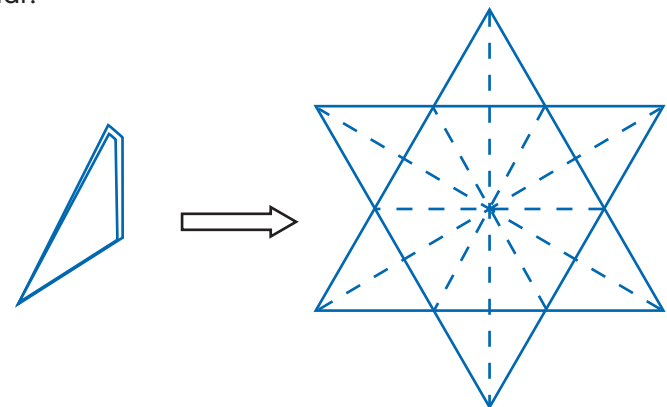

Constructing an Eight-Pointed Star

1. Using fig. 7, begin by carefully cutting out the circle.

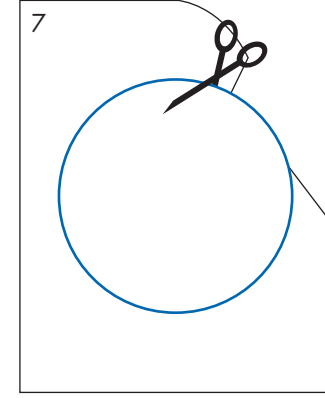

2. Fold the circle in half.



3. Fold A over to B.

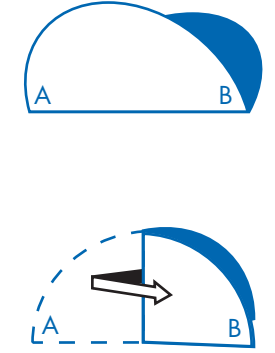

4. Fold B up to D, creating new point E.

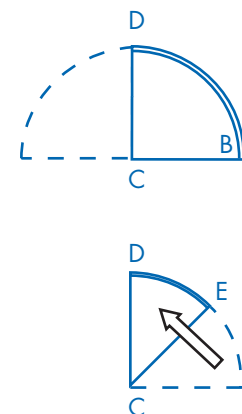

5. Draw a perpendicular line from line CD to point E. Fold D down along line EF, keeping a sharp point at E. Unfold.

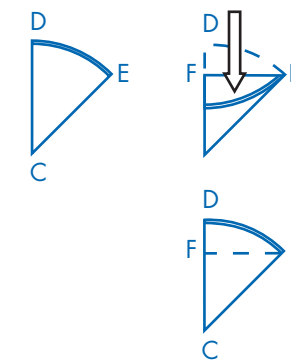

6. Draw a perpendicular line from line CE to point D. Fold E down along line DG, keeping a sharp point at D. Unfold.

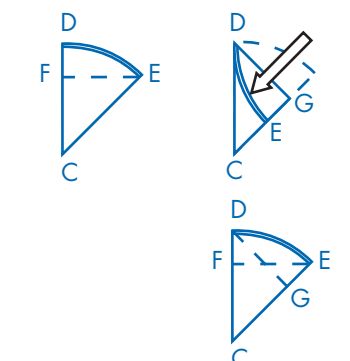

7. Cut along fold lines EF and DG only to the intersection.

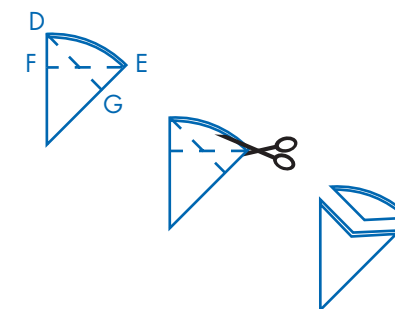

8. Open to discover an eight-pointed star.

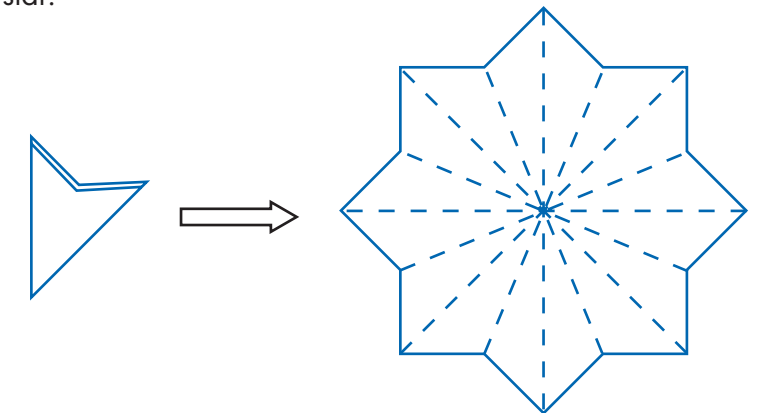

fig. 7

Circle

Decorating the Stars

Ask the students to decorate their stars. Look at the slides for ideas for patterns and designs. We suggest that the stars be placed on either a light colored or black background to enhance the students' decoration. Each student can make multiple stars to form his or her own panel, or individual students' stars can be combined to make a class panel. The stars should be mounted on the panel (poster board or paper) with their points touching, as shown below.

Six-pointed star panel

Eight-pointed star panel

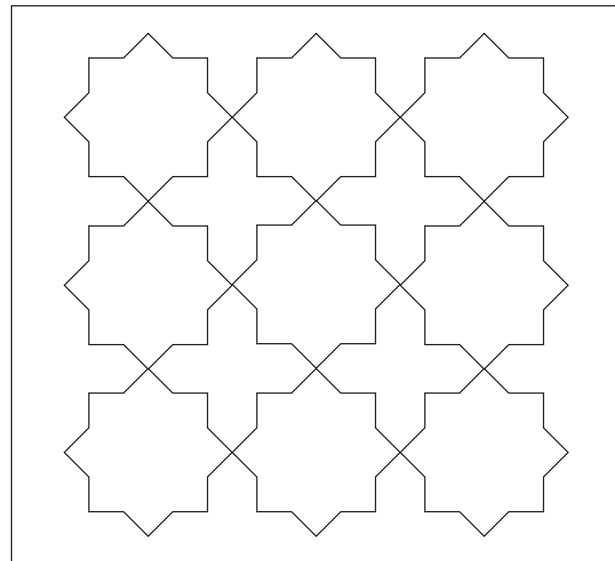
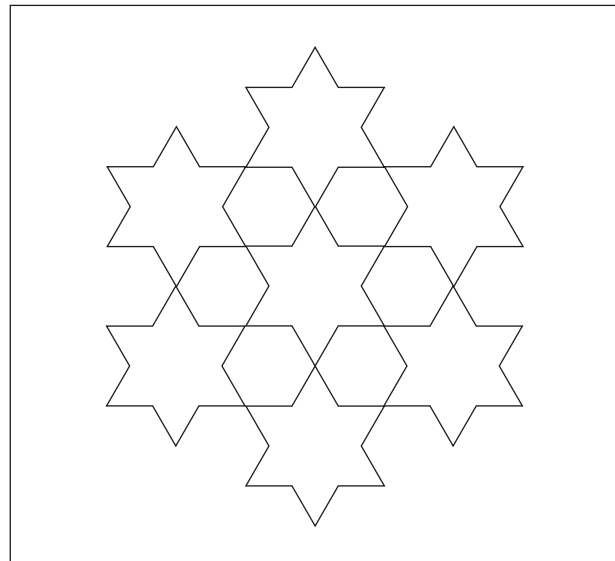

Once the project is completed, you may want to point out the star-hexagon pattern in the **Molded tile panel** (slide 5) and/or the **Tile panel in the star-cross pattern** (slide 7). Ask the students to compare these artworks to their own projects.

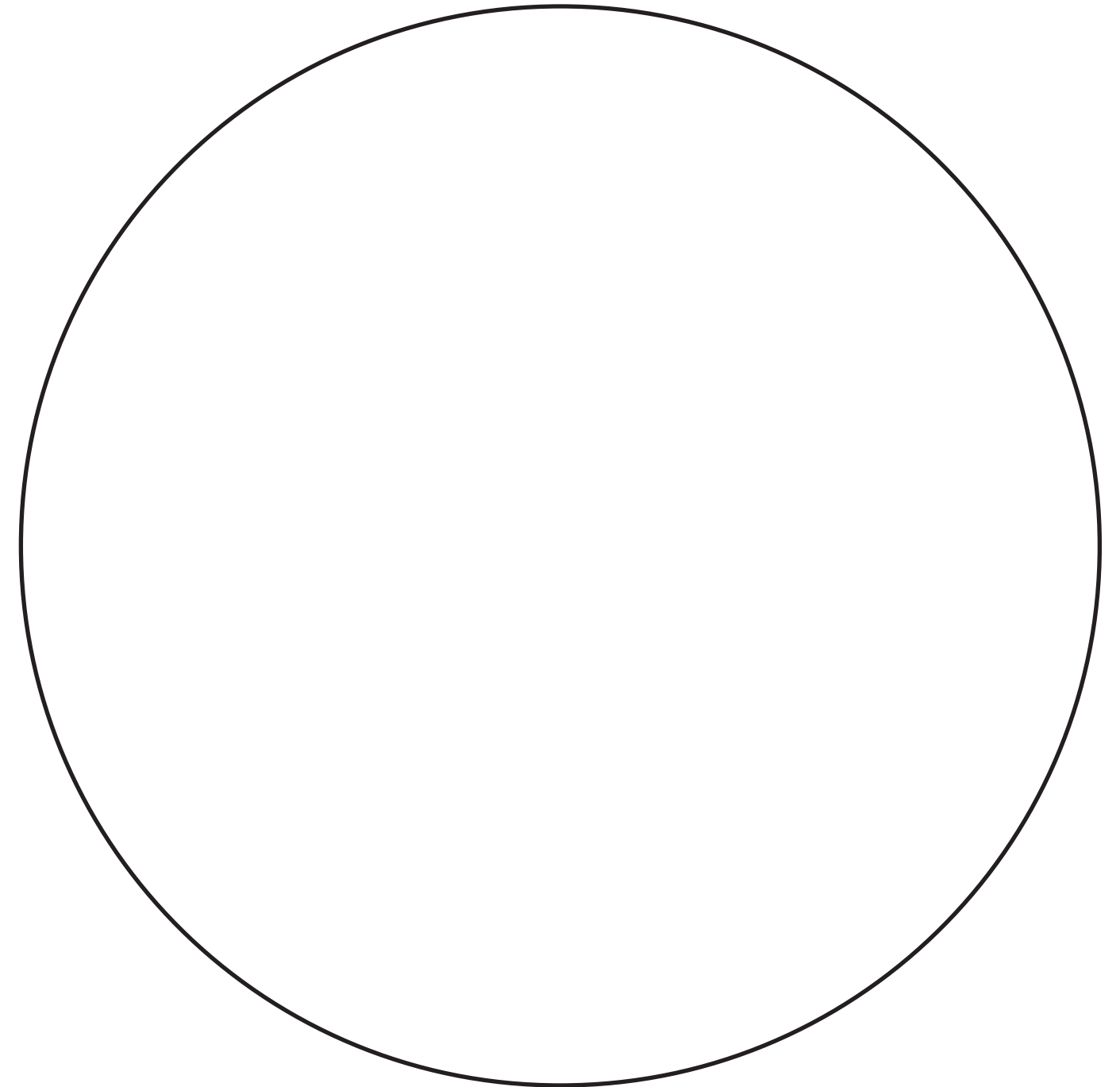

Resources and Glossary

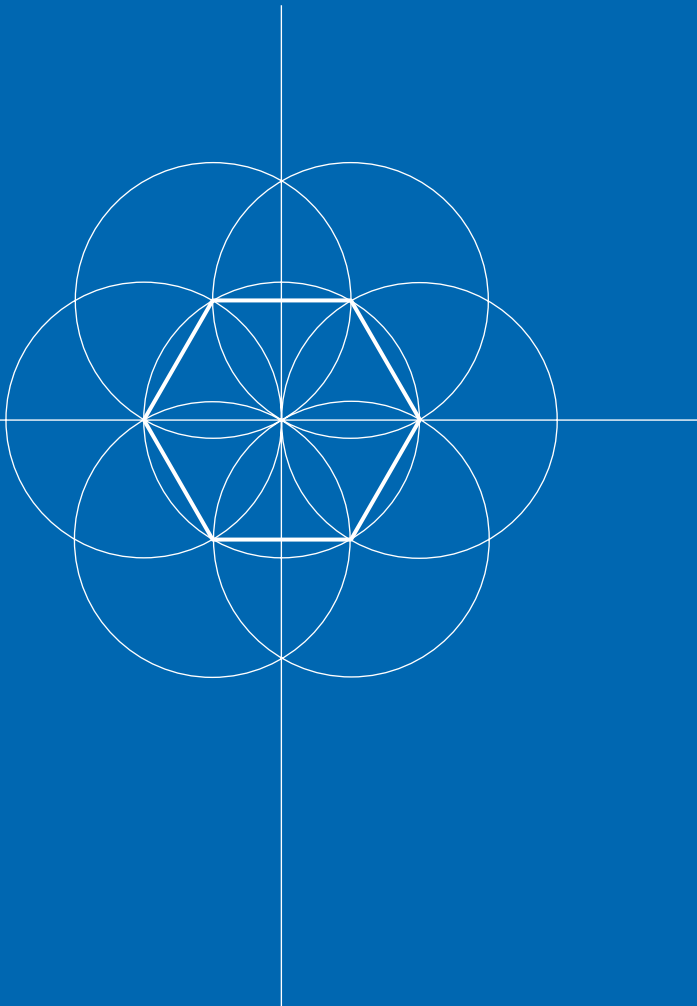

Selected Bibliography and Resources

Islamic World

Al-Qur'an (The Qur'an). Trans. Ahmed Ali. Princeton, N.J.: Princeton University Press, 1984.

Armstrong, Karen. *Islam: A Short History*. Modern Library Chronicle Series. New York: Modern Library, 2000.

Armstrong, Karen. *Muhammad: A Biography of the Prophet*. New York: Harper Collins, 1992.

Shabbas, Audrey, ed. *Arab World Studies Notebook*. Berkeley: AWAIR (Arab World and Islamic Resources), 1998.

Turner, Howard R. *Science in Medieval Islam: An Illustrated Introduction*. Austin: University of Texas Press, 1997.

The intellectual legacy left by the multinational and multiethnic scientific community (Christians, Jews, and Muslims from all over the Islamic world) of the ninth through thirteenth century is the subject of this illustrated, readable survey.

Islamic Art

Baer, Eva. *Islamic Ornament*. Edinburgh: Edinburgh University Press, 1998. Baer presents an historic survey of the function and significance of Islamic ornament spanning one thousand years, from the seventh through seventeenth century.

Blair, Sheila S., and Jonathan M. Bloom. *The Art and Architecture of Islam, 1250–1800*. New Haven: Yale University Press, 1994. Blair and Bloom, renowned scholars of Islamic art, provide a thoroughly readable and copiously illustrated detailed look at Islamic art from the time of the Mongol invasions in the thirteenth century to the beginning of the nineteenth century; a final chapter covers Islamic art and its relationship to the West in the nineteenth and twentieth centuries.

Bloom, Jonathan M., and Sheila S. Blair. *Islamic Arts*. London: Phaidon Press, 1997. Beginning with a definition of Islamic art, Bloom and Blair then describe it in this excellent, readable one-volume introduction.

Carboni, Stefano, and David Whitehouse. *Glass of the Sultans*. New York: The Metropolitan Museum of Art; Corning: Corning Museum of Glass; Athens: Benaki Museum; New Haven: Yale University Press, 2001.

Featuring more than 150 glass objects representing twelve centuries of Islamic glassmaking, this beautifully illustrated exhibition catalog includes essays on the history as well as the techniques of glass making.

Ettinghausen, Richard, Oleg Grabar, and Marilyn Jenkins-Madina. *Islamic Art and Architecture, 650–1250*. New Haven: Yale University Press, 2001.

This is an overview of Islamic art and architecture of Spain, Africa, and the Middle East from its beginnings to the mid-thirteenth century. Written by well-known scholars, this amply illustrated and readable book provides a well-balanced account and makes the age and its art come alive for the student and the general reader.

Robinson, Francis, ed. *Cambridge Illustrated History of the Islamic World*. Cambridge: Cambridge University Press, 1996.

An outstanding one-volume overview of the entire Islamic world from its rise in the seventh century to the end of the twentieth; well illustrated and engaging, it includes a chronology of all rulers and an extensive bibliography.

Stierlin, Henri. *Islamic Art and Architecture*. London: Thames and Hudson, 2002.

Stierlin, an architectural historian, has written a lavishly illustrated overview of Islamic art and architecture; the book includes detailed presentations on nine of the great masterpieces of Islamic architecture, including the Friday Mosque in Isfahan and the Taj Mahal in Agra.

Math and Geometry

Bourgoin, Jules. *Arabic Geometrical Pattern and Design*. New York: Dover Publications, 1974.

This book of patterns illustrates 190 examples of Islamic geometrical designs: hexagons, octagons, pentagons, heptagons, dodecagons, and more.

Critchlow, Keith. *Islamic Patterns: An Analytical and Cosmological Approach*. New York: Thames and Hudson, 1984.

Through progressively complex geometrical procedures, the author provides a foundation from basic building blocks of Islamic geometrical patterns to multifaceted designs.

El-Said, Issam. *Islamic Art and Architecture: The System of Geometric Design*. Reading, U.K.: Garnet Publishing, 1993.

This is a consideration of the background and construction of Islamic design. Written for the author's doctoral thesis, it explains the mathematical elements behind the designs.

Forseth, Sonia Daleki. *Creative Math/Art Activities for the Primary Grades*. Englewood Cliffs, N.J.: Prentice-Hall, 1984.

These lessons are designed to supplement and reinforce basic concepts for mathematics instruction from kindergarten through grade 3.

Henry, Boyd. *Experiments with Patterns in Mathematics: Enrichment Activities for Grades 7–12*. Palo Alto, Calif.: Dale Seymour Publications, 1987.

These fifty-five experiments utilizing patterns and numbers provide a wealth of ideas from polygonal numbers through pythagorean triples.

Newman, Rochelle, and Martha Boles. *The Golden Relationship: Art, Math, Nature*. Book 1. *Universal Patterns*, 2nd rev. ed. Book 2. *The Surface Plane*. Bradford, Mass.: Pythagorean Press, 1992.

Art and mathematics constructs are used here to help make connections and understand the recurring patterns in nature and in space. Forms and words are linked to explore patterns. Appendices include mathematical symbols, properties, and proofs; geometric formulas; art techniques; templates; and an illustrated glossary.

Norman, Jane, et al. *Patterns East and West: Introduction to Pattern in Art for Teachers*. New York: The Metropolitan Museum of Art, 1986.

Examples from a cross-section of the Metropolitan Museum's collection are compared, analyzed, and transformed (includes slides).

Stevens, Peter. *Handbook of Regular Patterns: An Introduction to Symmetry in Two Dimensions*. Cambridge, Mass.: MIT Press, 1981.

Stevens combines artistic symbols with mathematical explanations and relates designs from different cultures and periods in history.

Wade, David. *Pattern in Islamic Art*. Woodstock, N.Y.: The Overlook Press, 1976.

This pattern book illustrates the structure and development of Islamic patterns and provides descriptions and directions for construction.

Juvenile

Beshore, George. *Science in Early Islamic Culture*. Science of the Past. New York: Franklin Watts, 1998. Concise chapters on science, numbers, astronomy, geography, and medicine highlight these achievements in the Islamic world and their continuing impact on Western civilization.

George, Linda S. *The Golden Age of Islam*. Cultures of the Past. New York: Benchmark Books, 1998.

Covers the history, beliefs, society, and global legacy of Islam from the last years of the eighth century to the thirteenth century.

MacDonald, Fiona. *A 16th-Century Mosque*. Inside Story. New York: Peter Bedrick Books, 1994.

The design and construction of Istanbul's Suleymaniye mosque by the famous architect Sinan is the context for a discussion of all aspects of life in the Ottoman empire of the sixteenth century.

Videos

Islam. Produced and directed by Steve York; written by Michael Olmert. Alexandria, Va.: PBS Video, 1991. (VHS 58 min.) Smithsonian World (television program) Examines the history and culture of Islam.

Islam: A Civilization and Its Art. Produced and directed by Jo Franklin. Washington, D.C.: Pacific Productions, 1991. (VHS 90 min.) An informative and entertaining look at Islamic art and culture.

Other Sources

Timeline of Art History
www.metmuseum.org/toah

The Math Forum
<http://mathforum.org>
The Math Forum is a research and educational enterprise of Drexel University; the site has information and links for K–12, college, and advanced math topics.

Aramco World Magazine
Published six times annually to increase cross-cultural understanding of Arab and Muslim worlds. Free subscription for educators: Saudi Aramco World, Box 469008, Escondido, CA 92406-9008

Glossary

Allah

the Arabic word for “God,” the same monotheistic God worshipped in Judaism and Christianity, the God of Abraham, the God of Jesus

calligraphy

the art of elegant or stylized writing in which the word itself becomes a work of art: exceptionally skilled Muslim calligraphers gained honorific titles and fame

cartouche

a decorative oval or oblong-shaped panel with scrolled edges used in art and architecture as a base for inscriptions or other decorations, or used as a decoration in and of itself

cenotaph

a tomblike monument or memorial dedicated to a deceased person who is buried elsewhere

circle

a plane figure bounded by a single curved line, every point of which is equally distant from the point at the center of the figure

equilateral triangle

a triangle whose three sides are of equal length

Hadith

Islam’s second holiest book, literally “traditions” or “accounts” of Muhammad’s actions, sayings, and commentaries on the Qur’an, which together form the basis of Islamic law

idolatry

the worship of idols, or images of deities

Islam

literally “surrender,” “submission” to the will of God; the religion promulgated by Muhammad and followed today by about one-quarter of the world’s population

Kufic script

coming into use in the seventh century, this was used primarily for monumental purposes, its angular forms ideal for architectural decoration

marquetry

decoration achieved by inlaying patterns into precious woods or ivory

mihrab

a recessed niche in a mosque wall that indicates the direction of Mecca and marks the focus of congregational prayers, usually the most adorned and decorated element of the mosque

mina’i ware

a Persian style of pottery in which most colors are applied over the glaze

mosque (*masjid*)

literally “place of prostration,” where Muslims gather for prayer; a new mosque is built where the calls to prayer from the nearest mosque can no longer be heard

Muhammad

(b. Mecca, Arabia, ca. 570 A.D., d. Medina, 632 A.D.) recognized as “the messenger of God” by the Muslims, he was an Arab merchant who preached the Islamic faith, began receiving divine revelations about 610 A.D., and was forced to leave with his followers from Mecca to Medina in 622 A.D.

muqarnas

initially structural in purpose and made of stone, later decorative and crafted of plaster, these clustered niches or parts of niches were used to decorate the area between the walls and dome in Islamic architecture (also known as honeycomb or stalactite vaulting)

Muslim

a follower of Islam, literally “one who surrenders,” hence, one who has direct access to his/her God (Islam having no priesthood)

omphalos

from the Greek word for “navel,” a decorative motif consisting of a bump or knob within a circle

polygon

a plane figure with several angles and sides, usually more than four (see also regular polygon)

Qur’an

literally “recitation,” the holy book of Islam, containing God’s words as revealed in Arabic to Muhammad; the Qur’an contains 114 *suras*, or chapters

regular polygon

a polygon with equal sides and equal angles, e.g., an equilateral triangle, square, pentagon, hexagon, heptagon, or octagon (see also polygon)

regular tessellation

the only three regular tessellations that can exist are the tessellations by equilateral triangles, by squares, and by hexagons; the boundaries of these tessellations form the triangle grid, the square grid, and the hexagon grid (see also tessellation)

symmetry

correspondence in size, shape, and relative position of parts on opposite sides of a dividing line or medium plane or about a center or axis

tessellation

a covering of an infinite geometric plane without gaps or overlaps by congruent plane figures of one type or a few types (see also regular tessellation)

vegetal motifs

decoration reminiscent of plants, usually characterized by curving, twisting linear forms such as stalks or stems, as well as floral or leaf patterns

